

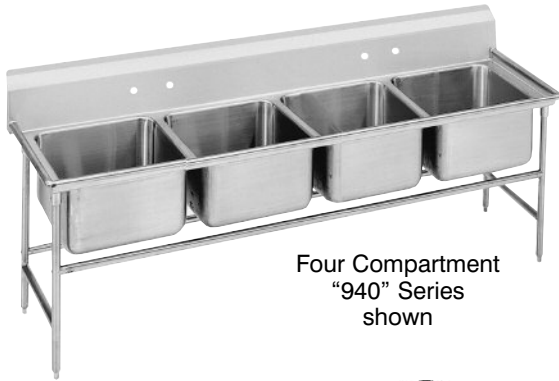

STAINLESS STEEL

# REGALINE SINKS

## Three & Four Compartments without Drainboards



Four Compartment  
"940" Series  
shown



Three Compartment  
"940" Series  
shown



Item #: \_\_\_\_\_ Qty #: \_\_\_\_\_  
 Model #: \_\_\_\_\_  
 Project #: \_\_\_\_\_

**FEATURES:**

Tile edge for ease of installation.  
 One piece **Deep Drawn** sink bowls with splash.  
 Featuring the single bowl unit design.  
 All sink bowls have a large liberal 3" radius.  
 Placement of the welded leg assembly ensures stability and furnishes direct support of the column load requirement for the entire sink unit.  
 "940" series is supplied with adjustable front and rear cross brace.

**CONSTRUCTION:**

All TIG welded.  
 Welded areas blended to match adjacent surfaces and to a satin finish.  
 Gussets welded to a die-embossed reinforcing channel.

**Spec-Line:** 940 Series - 11" High Splash.  
**Standard:** 930 Series - 8" Splash.  
**Super Saver:** 900 Series - 8" Splash.

**MATERIAL:**

**940 Series:** 14 gauge type 304 stainless steel.  
**930 Series:** 16 gauge type 304 stainless steel.  
**900 Series:** 18 gauge type 304 stainless steel.

- LEGS:**
- 1 5/8" diameter tubular stainless steel.
  - Stainless steel gussets and gussets.
  - Stainless Steel 1" adjustable bullet feet.

**YES! It's SeaLess!**

BOWL SIZE	O.A. LENGTH (inches) (mm)	# of Compartment	SPEC-LINE 940 Series		STANDARD 930 Series		SUPER SAVER 900 Series		Cubic Feet	
			14 Ga. 304 S/S 14" Water Level		16 Ga. 304 S/S 12" Water Level		18 Ga. 304 S/S 12" Water Level			
			MODEL #	Approx. Wt. (lbs.)	MODEL #	Approx. Wt. (lbs.)	MODEL #	Approx. Wt. (lbs.)		
<b>16 x 20</b> (406 x 508)	62"	1575	Three	<b>94-3-54</b>	114	<b>93-3-54</b>	90	<b>9-3-54</b>	89	28
	† 81"	2057	Four	<b>94-4-72</b>	192	<b>93-4-72</b>	176	<b>9-4-72</b>	155	44
<b>20 x 20</b> (508 x 508)	74"	1880	Three	<b>94-23-60</b>	210	<b>93-23-60</b>	165	<b>9-23-60</b>	149	44
	† 97"	2464	Four	<b>94-24-80</b>	220	<b>93-24-80</b>	195	<b>9-24-80</b>	179	56
<b>18 x 24</b> (457 x 610)	68"	1727	Three	<b>94-63-54</b>	219	<b>93-63-54</b>	130	<b>9-63-54</b>	174	36
	89"	2248	Four	<b>94-64-72</b>	312	<b>93-64-72</b>	283	<b>9-64-72</b>	255	56
<b>24 x 24</b> (610 x 610)	† 86"	2184	Three	<b>94-43-72</b>	225	<b>93-43-72</b>	200	<b>9-43-72</b>	200	56
	† 113"	2870	Four	<b>94-44-96</b>	330	<b>93-44-96</b>	300	<b>9-44-96</b>	300	74
<b>20 x 28</b> (508 x 711)	74"	1880	Three	<b>94-83-60</b>	255	<b>93-83-60</b>	225	<b>9-83-60</b>	225	65
	† 97"	2464	Four	<b>94-84-80</b>	345	<b>93-84-80</b>	310	<b>9-84-80</b>	310	78
† Requires Two Faucets				14" Water Level 17" Flood Level		12" Water Level 15" Flood Level		12" Water Level 15" Flood Level		



Customer Service Available To Assist You **1-800-645-3166** 8:30 am - 8:00 pm E.S.T.

Email Orders To: [customer@advancetabco.com](mailto:customer@advancetabco.com). For Smart Fabrication™ Quotes, Email To: [smartfab@advancetabco.com](mailto:smartfab@advancetabco.com) or Fax To: 631-586-2933

**NEW YORK**  
 Fax: (631) 242-6900

**GEORGIA**  
 Fax: (770) 775-5625

**TEXAS**  
 Fax: (972) 932-4795

**NEVADA**  
 Fax: (775) 972-1578

# DIMENSIONS and SPECIFICATIONS

TOL Overall: ± .500"  
Interior: ± .250"

ALL DIMENSIONS ARE TYPICAL

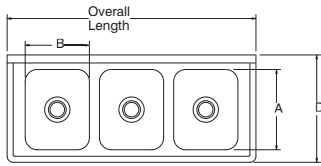

3 Compartment

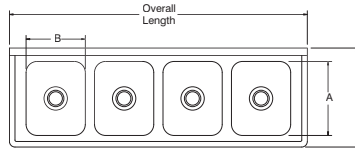

4 Compartment

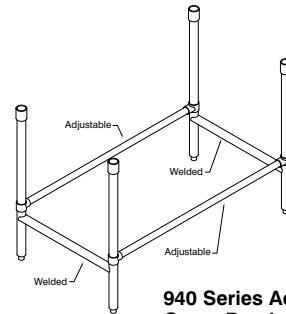
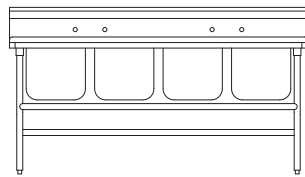
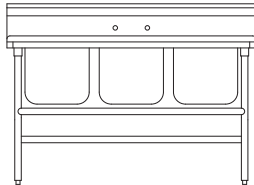

940 Series Adjustable Cross Bracing

## DESCRIPTION

BOWL (SIZE)	# of Compart.	Overall Length	Recommended Use	A	B	C	D	940 SERIES					900 & 930 SERIES				
								V	W	X	Y	Z	V	W	X	Y	Z
16x20	Three	62"	DISH SINKS	20"	16"	13 5/8"	27"	38"	11"	14"	20"	45"	38"	8"	12"	22"	42"
	Four	†81"															
20x20	Three	74"	DISH & POT SINKS	20"	20"	13 5/8"	27"	38"	11"	14"	20"	45"	38"	8"	12"	22"	42"
	Four	†97"															
18x24	Three	68"	POT & PAN SINKS	24"	18"	15 5/8"	31"	38"	11"	14"	20"	45"	38"	8"	12"	22"	42"
	Four	†89"															
24x24	Three	*86"	POT SINKS	24"	24"	15 5/8"	31"	38"	11"	14"	20"	45"	38"	8"	12"	22"	42"
	Four	†113"															
20x28	Three	74"	PAN SINKS	28"	20"	17 5/8"	35"	38"	11"	14"	20"	45"	38"	8"	12"	22"	42"
	Four	†97"															

\* Requires 2 Faucets

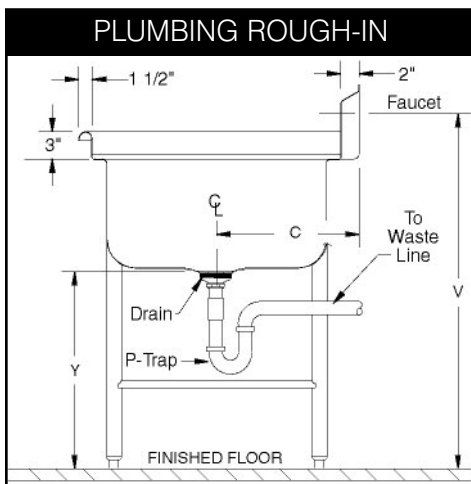

## MECHANICAL:

- Supply is 1/2" IPS hot & cold.
- Faucet holes on 8" centers.
- Faucets are not included (**see accessories**).
- Waste drains are 1 1/2" IPS S/S basket type, located in center of sink bowl, and are included.

