

Food Bars

Buffet

Models BBR720 - 6 ft. (172 cm), BBR480 - 4 ft. (130 cm)

Features & Benefits



- Easily turns any table into a profit producing food buffet bar.
- All models accommodate GN 1/1 Full or Fractional Size Food Pans, 2 1/2" (6,5 cm) or 4" (10 cm) deep, with DIV12 and DIV20 Divider Bars.
- Double-wall polyethylene construction provides extra strength, durability and reliability. Scratch-resistant textured exterior. Simple to clean - just wipe off.
- Thick polyurethane, foam-insulated ice well holds ice for hours to keep food presentation fresh.
- Drain plug is included to offer quick and easy clean up.
- Standard accessories include protective sneeze guard, made from NSF listed material.
- Sneeze Guard and Buffet Bar Base are available separately to offer even greater merchandising opportunities.
- Optional accessories include Divider Bars, Crock Holder, and Salad Bowl Holders.
- Non-electrical.
- Easy to assemble.
- Available in 15 colors.

Item No. _____

Specifier Identification No. _____

Model No. _____

Quantity _____

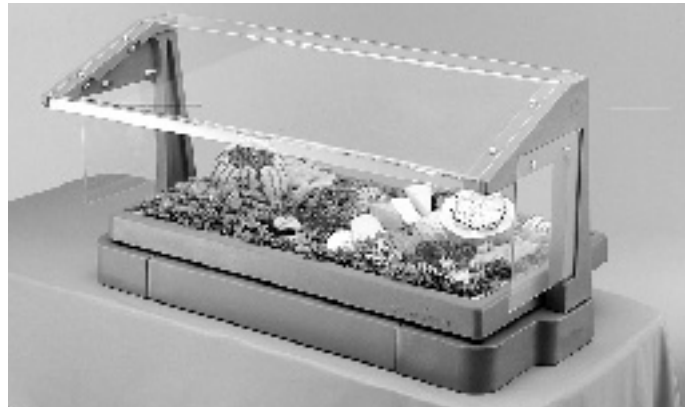

BBR480
(Sneeze Guard and Buffet Bar Base)



FSG480
(Sneeze Guard)



BUF48
(Buffet Bar Base)

Set Up Guide for Buffet Food Bars

Salad Bowls and Crockes

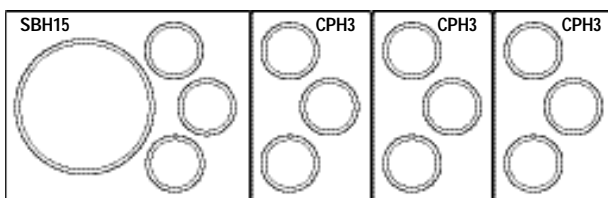
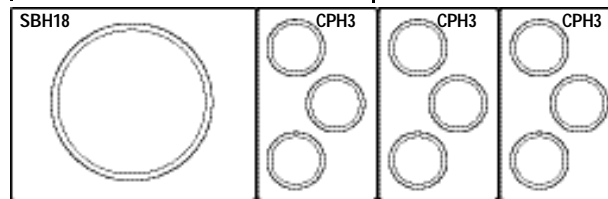
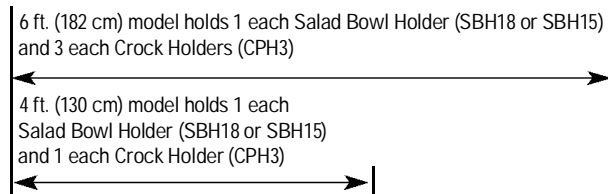

SBH18 - Holds 1 each 18" (45,7 cm) Salad Bowl
 SBH15 - Holds 1 each 15" (38 cm) Salad Bowl & 3 each 1.5 qt. (1,4 L) Crockes
 CPH3 - Holds 3 each 1.5 qt. (1,4 L) Crockes

Food Pans

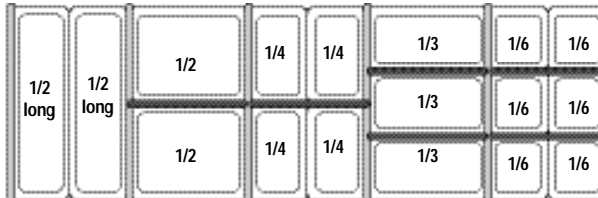
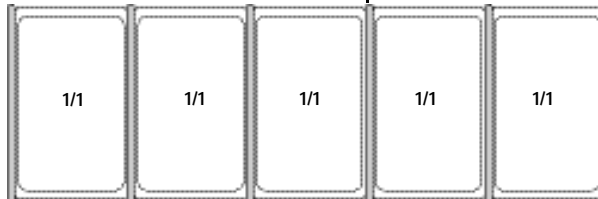
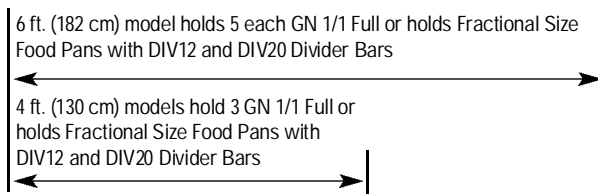

GN 1/1 Full Size Food Pans

← DIV20 20 7/8" (53 cm) Divider Bar

GN Fractional Size Food Pans

← DIV12 12 1/4" (32,5 cm) Divider Bar

Approvals



Food Bars

Buffet

Models BBR720 - 6 ft. (172 cm), BBR480 - 4 ft. (130 cm)

Item No. _____

Specifier Identification No. _____

Model No. _____

Quantity _____

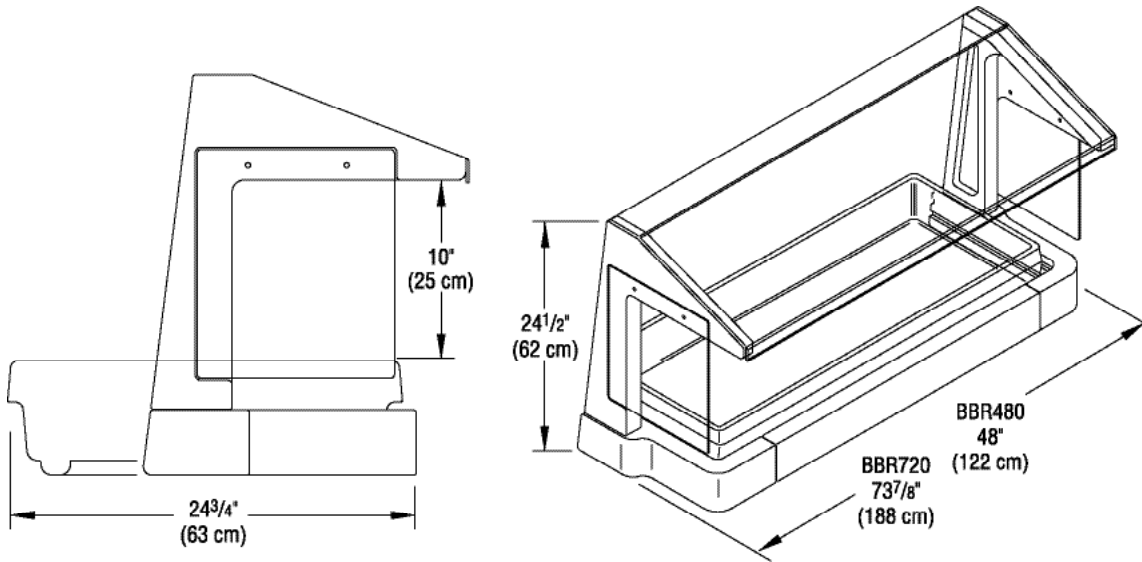

Specifications

Dimension Tolerance: +/- 1/4" (0,64 cm)

Code	Description	GN 1/1 Full Size Food Pan Capacity	Exterior Dimensions L x W x H	Case lbs./cube Kg/m ³
BBR720	6 ft. (182 cm) Buffet Food Bar	5	73 7/8" x 24 3/4" x 24 1/2" (188 x 63 x 62 cm)	67 (20.74) 30,5 (0,58)
BBR480	4 ft. (130 cm) Buffet Food Bar	3	48" x 24 3/4" x 24 1/2" (122 x 63 x 62 cm)	50 (10.88) 23 (0,3)

Optional Accessories

- Divider Bars DIV12 DIV20
- 3-Crock Holder CPH3 (holds 1.5 qt. (1,4 L) and 2.7 qt. (2,4 L) crocks)
- Salad Bowl Holders SBH15 (holds 1 each 15" (38 cm) bowl and 3 crocks)
 SBH18 (holds 1 each 18" (45,7 cm) bowl)
- Free Standing Sneeze Guard FSG720 FSG480
- Buffet Bar Base BUF72 BUF48

Standard Colors

- Black (110)
- Coffee Beige (157)
- Navy Blue (186)
- Green (519)
- Granite Green (192)
- Slate Blue (401)
- Dark Brown (131)
- Dusty Rose (400)
- Hot Red (158)
- Granite Red (193)
- Brick Red (402)
- Cold Blue (159)
- Gray (180)
- Granite Gray (191)
- Granite Sand (194)

Divider Bar:

- White (148)
- Clear (035)

Crock Holder and Salad Bowl Holder:

- White (148)

Architect Specs

The non-electrical foodservice buffet bar shall be Model..., manufactured by Cambro Mfg. Co., Huntington Beach, CA 92648 U.S.A. It shall be made of seamless, double-wall high-density polyethylene and shall be foam-injected with polyurethane. It shall be offered complete with Buffet Bar Base and Sneeze Guard or each component shall be offered separately. It shall be available in 2 lengths and shall accommodate 3 or 5 each, GN 1/1 Full Size Food Pans, up to 4" (10 cm) deep, or Fractional Size Food Pans with Divider Bars. It shall have a drain plug. It shall hold optional Cambro Salad Bowl (SBH18 and SBH15) Holders and Crock Holders (CPH3). The depth of the interior of the Buffet Bar Base shall be 5" (13 cm). It shall be available with a protective sneeze guard made of NSF listed material. It shall require minimal assembly. It shall be available in 15 colors.

Approvals

