



ROYAL SERIES UNDERBAR REAR CORNER DRAINBOARDS

MODEL: _____ PROJECT: _____ ITEM #: _____ QTY: _____

PRODUCT IMAGE



KR18-DRC90 SHOWN

AVAILABLE IN 1800 or 2100 SERIES

STANDARD FEATURES

- **Drainboard**
20 gauge embossed stainless steel reinforced with welded braces every 6 inches. $\frac{3}{4}$ " radius on all vertical and horizontal edges
- **Front Apron**
20 gauge stainless steel clad over 20 gauge galvanized steel
- **Sides**
20 gauge stainless steel
- **Backsplash**
20 gauge stainless steel
- **Back and Bottom**
20 gauge stainless steel
- **Plumbing**
1" IPS drain connection



CERTIFICATIONS:

APPROVED BY:

Due to our commitment to continued product improvement, specifications are subject to change without notice.

Printed in the USA

Krowne Metal Corporation

100 Haul Rd. Wayne, NJ 07470 • Toll Free: (800) 631-0442 • Fax: (973) 872-1129
sales@krowne.com • www.krowne.com • www.facebook.com/KrowneMetal • www.twitter.com/KrowneMetal

Rev. 09/2011
No. 5.27

ROYAL SERIES UNDERBAR REAR CORNER DRAINBOARDS

MODEL: _____ PROJECT: _____ ITEM #: _____ QTY: _____

1800 SERIES: KR18-DR45

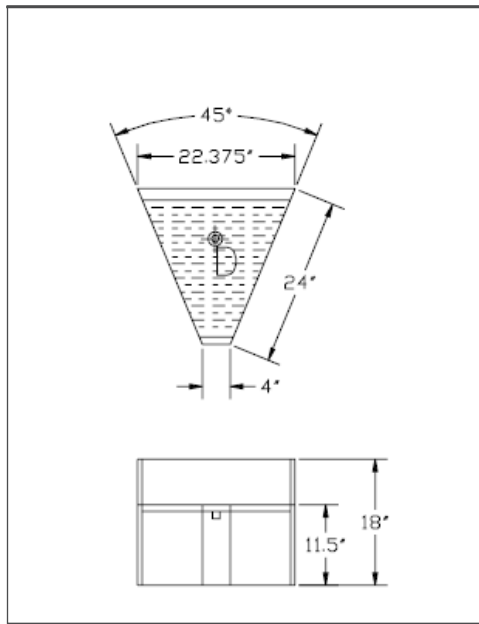

1800 SERIES: KR18-DRC45

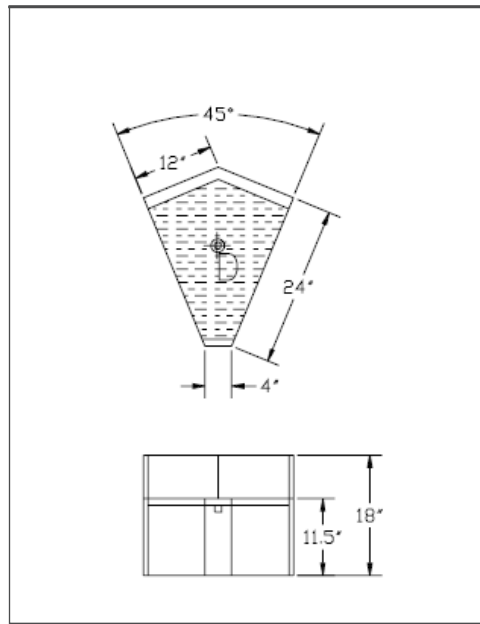

1800 SERIES: KR18-DRC90

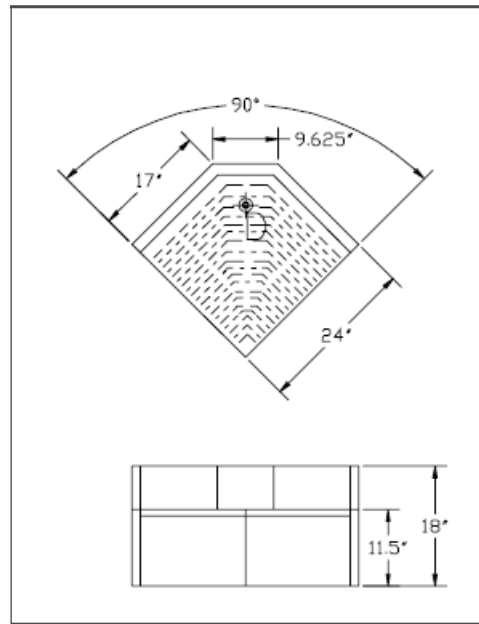

2100 SERIES: KR21-DR45

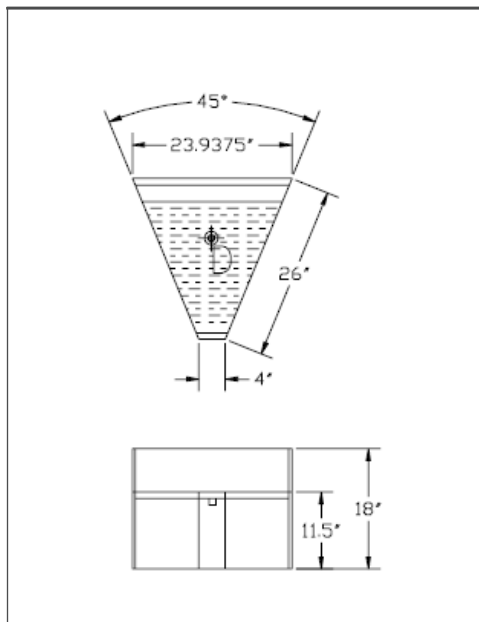

2100 SERIES: KR21-DRC45

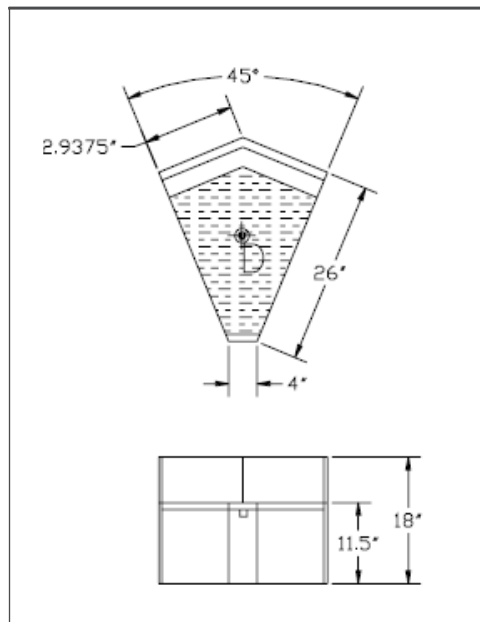

2100 SERIES: KR21-DRC90

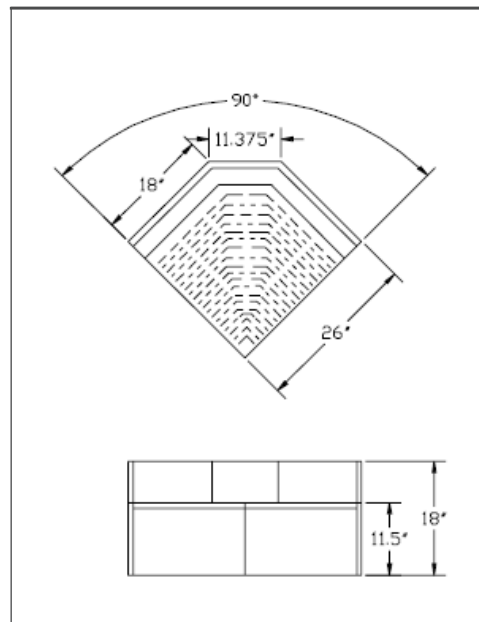

APPROVED BY:

CERTIFICATIONS:

Due to our commitment to continued product improvement, specifications are subject to change without notice.