



T&S BRASS AND BRONZE WORKS, INC.

2 Saddleback Cove / P.O. Box 1088
Travelers Rest, SC 29690

Model No.

B-0211

Item No.

Travelers Rest, SC: 800-476-4103 • Simi Valley, CA: 800-423-0150 • Fax: 864-834-3518 • www.tsbrass.com

This Space for Architect/Engineer Approval

Job Name _____ Date _____

Model Specified _____ Quantity _____

Customer/Wholesaler _____

Contractor _____

Architect/Engineer _____



ADA Compliant

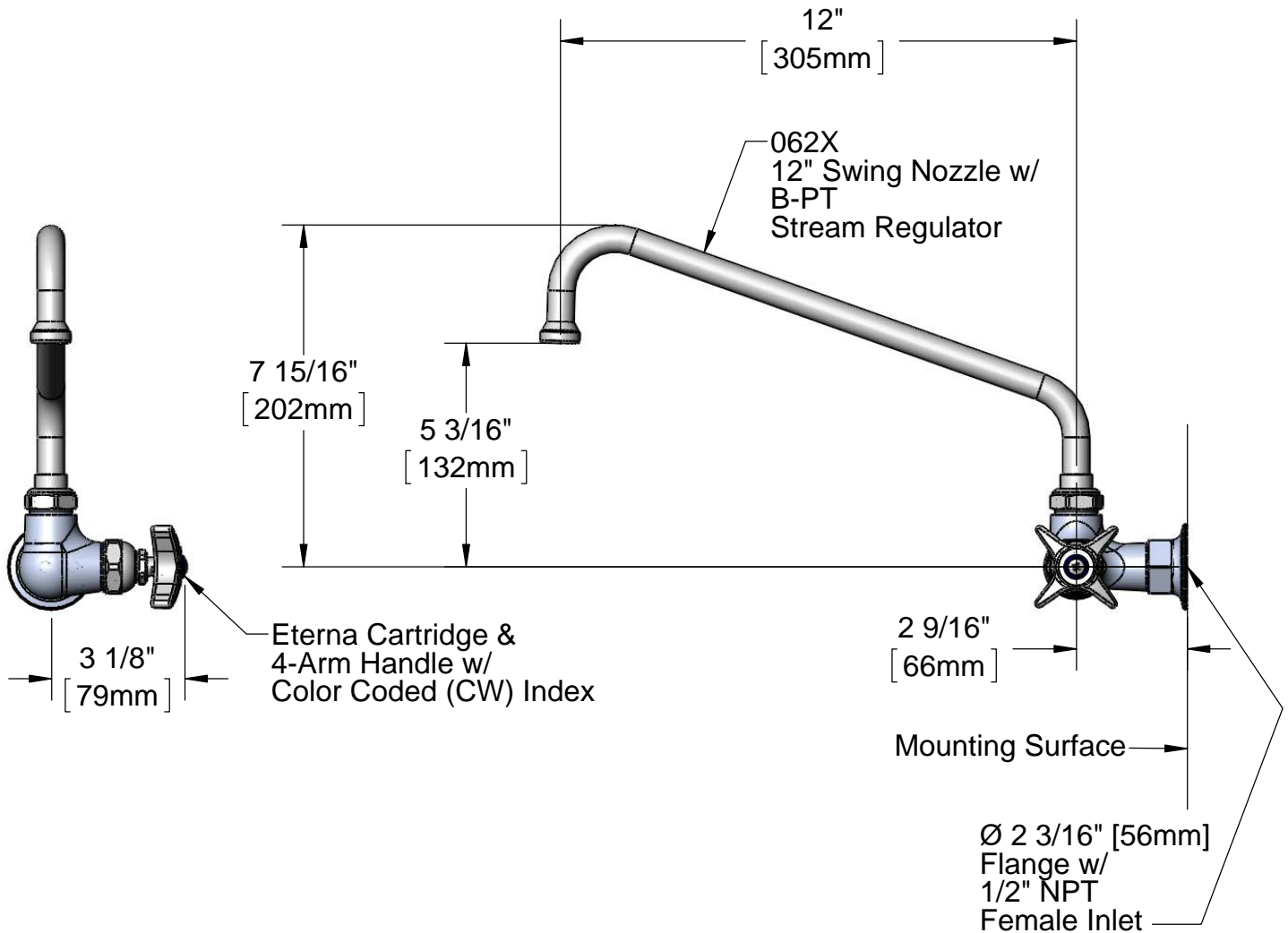
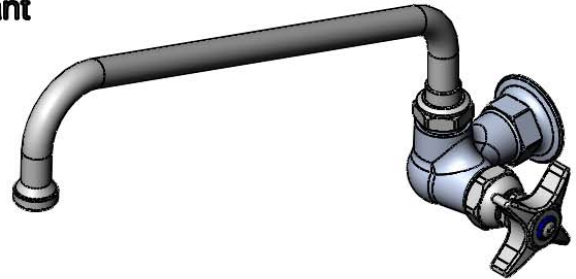

Product Specifications:

Single Hole Wall Mount Faucet w/ 4-Arm Handle, Eterna Cartridge, 12" Swing Nozzle & 1/2" NPT Female Inlet

Drawn

DHL

Checked

GEF

Approved

JHB

Scale:

1:8

Date:

02/03/12



T&S BRASS AND BRONZE WORKS, INC.

2 Saddleback Cove / P.O. Box 1088
Travelers Rest, SC 29690

Model No.
B-0211

Item No.

Travelers Rest, SC: 800-476-4103 • Simi Valley, CA: 800-423-0150 • Fax: 864-834-3518 • www.tsbrass.com

ITEM NO.	SALES NO.	DESCRIPTION
1	B-PT	Stream Regulator
2	001048-45	Nozzle Tip Washer
3	062X	12" Swing Nozzle
4	009538-45	Swivel Washer
5	011429-45	Swivel Sleeves (2)
6	001074-45	O-Ring
7	005960-40	Eterna Cartridge (RTC)
8	002521-45	4-Arm Handle
9	001660-45	Blue Index-CW
10	000922-45	Lever Handle Screw

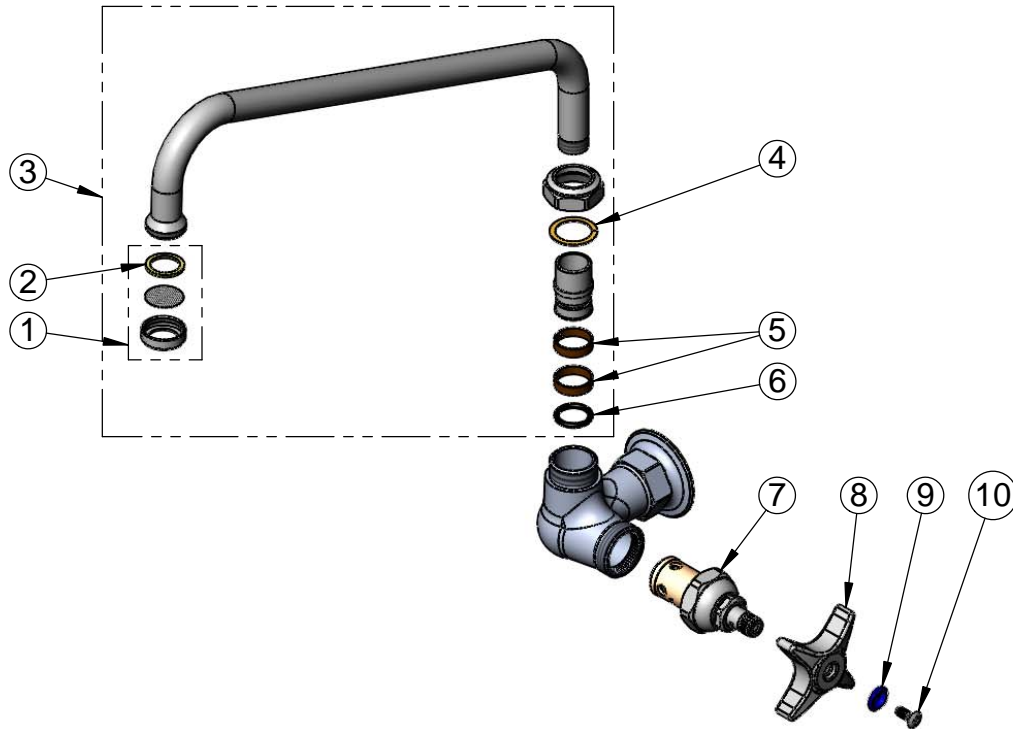

Product Specifications:
Single Hole Wall Mount Faucet w/ 4-Arm Handle, Eterna Cartridge,
12" Swing Nozzle & 1/2" NPT Female Inlet

Drawn DHL	Checked GEF	Approved JHB
Scale: NTS		Date: 02/03/12