

Project: _____ Location: _____ Item #: _____ Quantity: _____

Standard Features

- Fast cook times with patent-pending Steam Vector Technology, which utilizes no moving parts
- Cook mode and Variable Temperature Hold mode
- Easy-to-use digital controls, with digital temperature display
- No hood required (in most states)
- Independent digital electronic timer with programmable preset
- 3 Gallon water reservoir
- No water or drain line
- No water filtration or treatment required
- No warranty exclusions for water quality
- Front-mounted drain valve
- No scheduled de-liming or maintenance
- Heavy-duty, field-reversible door
- Door can be opened at any time during cooking cycle
- Cast aluminum heating element is not exposed to water
- Multiple kW heat inputs available for all cooking needs
- Steamer cavity constructed of reinforced 14 ga. 304 stainless steel
- Easy-to-clean control panel
- Automatic altitude compensation
- Dishwasher-safe one-piece wire pan racks
- Dishwasher-safe SVT steam collector and distributor panels
- English and Spanish operating instructions on door
- Simplified service access panel
- Low water, high water and overtemp indicator lights
- 5' power cord with plug included
- One year parts and labor warranty
- Lifetime Service & Support Guarantee
- UL LISTED Safety Certification (UL 197)
- UL EPH Sanitation Certification (NSF 4)

Optional Features

- Bullet Feet
- Stainless steel support stand available with casters, bullet feet or flanged feet
- Perforated cooking shelf
- Drain pan

Environmental Approvals & Programs



Other Approvals



Pan Capacities

Pan Size	Qty.
#200 full size (12x20x2.5")	6
#400 full size (12x20x4")	4

Short Spec

Evolution steamer is AccuTemp Products' connectionless, boilerless steam cooker that utilizes AccuTemp's Patent Pending Steam Vector Technology for faster cook times, improved energy efficiency, better pan to pan uniformity. Steam Vector Technology requires no moving parts inside the cooking chamber. Steam to be produced inside the cooking cavity with no heating element exposed to water. No water or drain line. Unit to include low water, high water, overtemp warning lights and auto shut off feature. Evolution to include heavy duty, field reversible door. Standard digital controls with independent timer. No water quality exclusions to warranty and no water filtration or treatment required. Unit to be UL Safety and Sanitation Certified, and Energy Star qualified. Built in USA.



E6 Evolution Model shown with optional drain pan and bullet feet

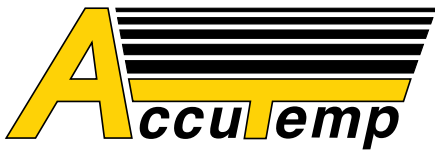

E6 TABLETOP CONNECTIONLESS EVOLUTION

6 Pan, Electric Boilerless Convection
Connectionless Countertop Steamer

Steamer Model "D" Specifications														
Model #	E62081D060	E62083D100	E62083D150	E62083D170	E62401D060	E62403D110		E62403D130	E62301D070	E64155D110			E64803D140	
Volts AC	208	208	208	208	240	208	240	240	230	380	400	415	440	480
Phase	1	3	3	3	1	3		3	1	5			3	
Amps	29	28	42	47	25	22	26	32	32	14	14	15	16	17
Breaker Size	30 amp	30 amp	50 amp	50 amp	30 amp	30 amp		50 amp	50 amp	20 amp			20 amp	
Watts (kW)	6	10	15	17	6	8	11	13	7	9	10	11	12	14
NEMA Plug	L6-30P	L15-30P	15-50P	15-50P	L6-30P	L15-30P		15-50P	IEC 60309-2 220/250V	IEC 60309-2 220/380-240/415V			L16-20P	

Notes:

1. Allow 3" between fryer, ranges, and other hot surfaces.
2. 5' power cord supplied with single or 3 phase.
3. For use on individual branch circuit only.
4. Do not connect to a circuit operating at more than 150V to ground.
5. Dimensions outside brackets are inches, in brackets are millimeters.

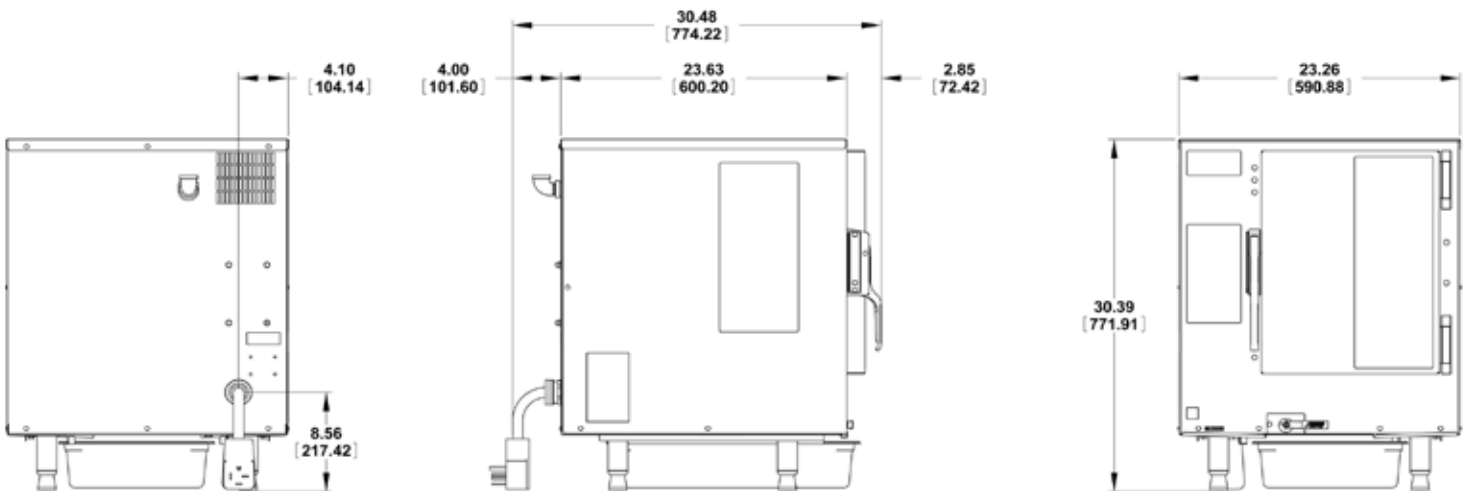
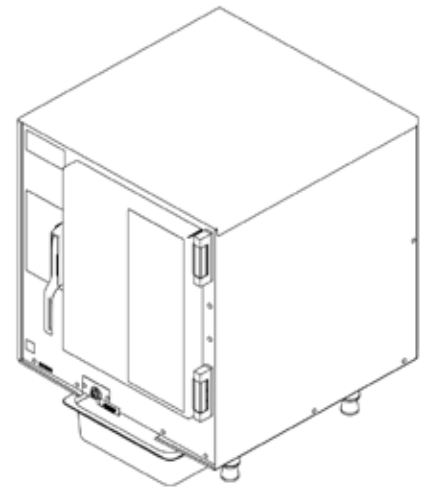
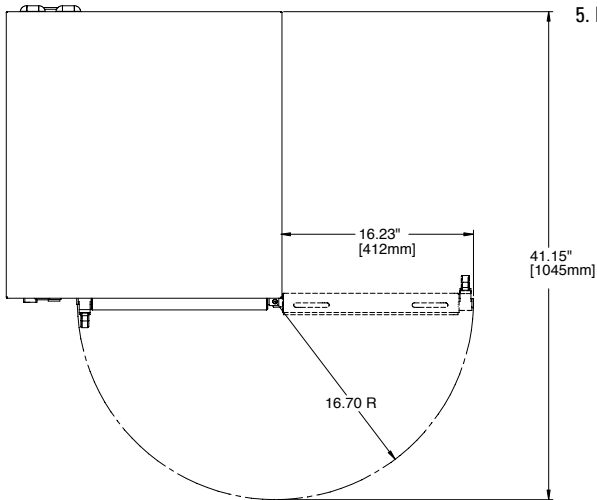

MM4221-0910