

400-HW SERIES HOT FOOD DROP-IN WELL

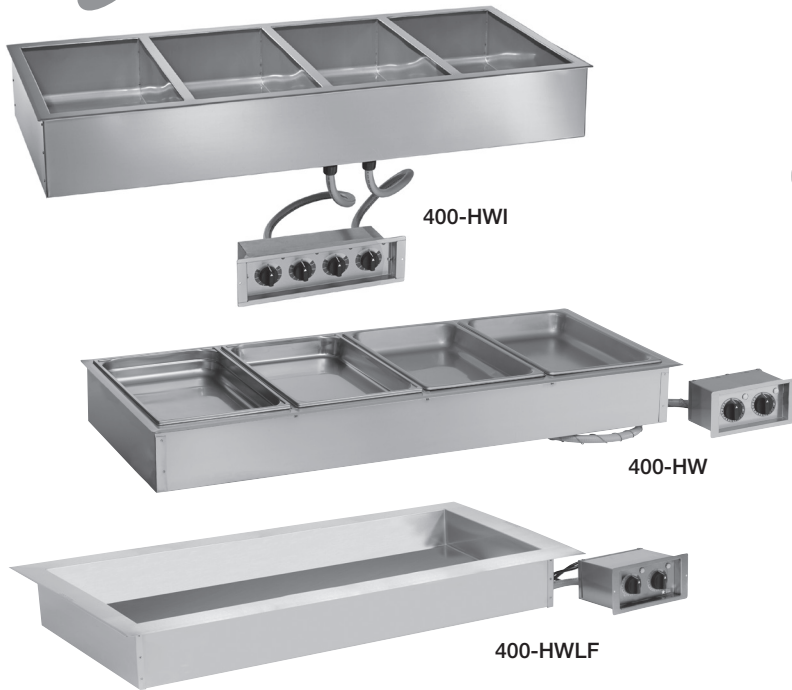

- The gentle heating capability of HALO HEAT significantly extends hot food holding life without continuing the cooking process.

- Provides a more appealing product with better appearance and fresher taste.
- Front-of-the-house use with an existing counter, overhead lighting, and sneeze guard system or drop into a prep table for hot food plating convenience.
- Easy drop-in installation without the need of water or drainage connections and the related installation and water usage costs.
- Maintenance savings with the elimination of lime and scale buildup associated with steam table holding.
- Increase employee safety with the elimination of burning steam when changing pans.
- Adjustable thermostats with remote control suitable for mounting provides holding temperature flexibility without high steam table temperatures to scorch or burn.
- Stainless steel interior walls are easy to clean with coved corners on two sides of the well.
- HWI series with individual wells and independent controls expands your menu options.



CE IP X3

The 400-HW is a heated hot food well with an exterior of 18 gauge stainless steel. The hot well includes stainless steel interior walls with coved corners on two sides. HWI and HWILF models are controlled by four (4) adjustable thermostats with a range of 1 through 10 and an indicator light. HW and HWLF models are controlled by two (2) adjustable thermostat with a range of 1 through 10 and an indicator light. The thermostat control is attached to the hot well base by two (2) 72" (1829mm) flexible and water tight conduits.

The heated well base is available in two depths. The 4-3/8" (111mm) deep unit holds 4" (102mm) deep pans and the 6-3/8" (162mm) deep unit holds 6" (153mm) deep pans. Both units will hold a combination of standard (gastronorm) pan sizes. The hot well includes eight (8) pan divider bars. The HW and HWLF hot well includes eight (8) half-size/third-size pan divider bars. The HWI and HWILF hot well includes eight (8) half-size/third-size pan divider bars.

- MODEL 400-HW/D4: 4-3/8" (111mm) depth, accepts four (4) full-size (gastronorm) pans
- MODEL 400-HW/D6: 6-3/8" (162mm) depth, accepts four (4) full-size (gastronorm) pans
- MODEL 400-HWLF/D4: 4-3/8" (111mm) depth, accepts four (4) full-size (gastronorm) pans
- MODEL 400-HWLF/D6: 6-3/8" (162mm) depth, accepts four (4) full-size (gastronorm) pans
- MODEL 400-HWI/D4: 4-3/8" (111mm) depth, accepts four (4) full-size (gastronorm) pans
- MODEL 400-HWI/D6: 6-3/8" (162mm) depth, accepts four (4) full-size (gastronorm) pans
- MODEL 400-HWILF/D4: 4-3/8" (111mm) depth, accepts four (4) full-size (gastronorm) pans
- MODEL 400-HWILF/D6: 6-3/8" (162mm) depth, accepts four (4) full-size (gastronorm) pans

FACTORY INSTALLED OPTIONS

- Voltage Choices:
 - 120V
 - 208-240V
 - 230V
- Control Box Cord Location:
 - Back, Standard
 - Bottom, Option



W164 N9221 Water Street • P.O. Box 450 • Menomonee Falls, Wisconsin 53052-0450 • U.S.A.

PHONE: 262.251.3800 800.558.8744 U.S.A./CANADA FAX: 262.251.7067 800.329.8744 U.S.A. ONLY

www.alto-shaam.com

INSTALLATION REQUIREMENTS

Unit must be installed level and must not be installed in any area where it may be directly affected by steam, grease, dripping water, high temperatures, or any other severely adverse conditions.

Hot well outer walls can reach 200° to 260°F (93° to 127°C). Verify countertop material temperature rating with manufacturer before installing hot well to ensure countertop can withstand heat.

CLEARANCE REQUIREMENTS

1" (25mm) from combustible surfaces

OPTIONS & ACCESSORIES

- Pan Divider Bar — HALF-SIZE / THIRD-SIZE 11318
- Pan Divider Bar — FULL-SIZE 16019

400-HW PRODUCT \ PAN CAPACITY BASED ON 4" DEEP PANS	
D4: 96 lb (44 kg) MAX. MAX. VOLUME: D4: 58 qt. (56 L)	
FULL-SIZE PANS*:	Four (4) 12" x 20" x 4" GN 1/1 (325mm x 530mm x 102mm)
HALF-SIZE PANS*:	Eight (8) 12" x 10" x 4" GN 1/2 (325mm x 265mm x 102mm)
THIRD-SIZE PANS*:	Twelve (12) 12" x 6" x 4" GN 1/3 (325mm x 176mm x 102mm)

*WILL ALSO ACCEPT 2-1/2" (102mm) DEEP PANS; D6 UNITS WILL ACCEPT 6" (153mm) DEEP PANS

400-HW SERIES

HOT FOOD DROP-IN WELL

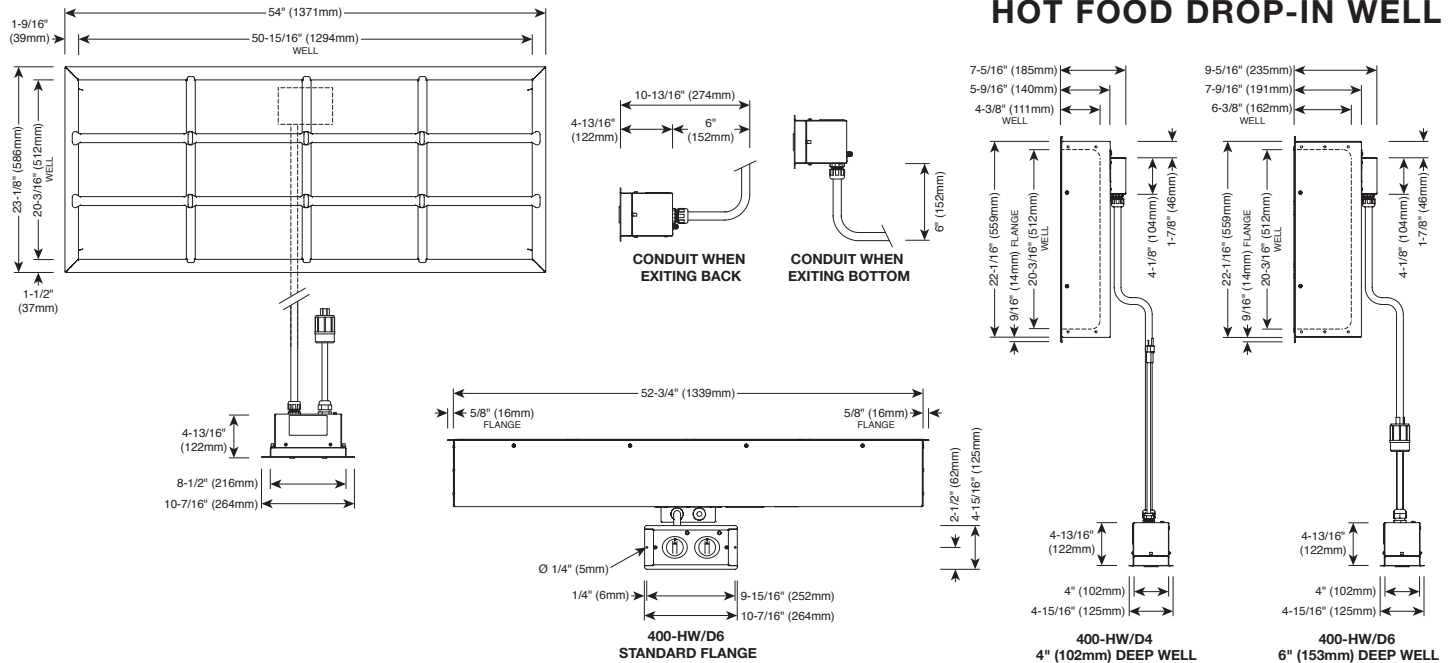

400-HWLF SERIES

HOT FOOD DROP-IN WELL

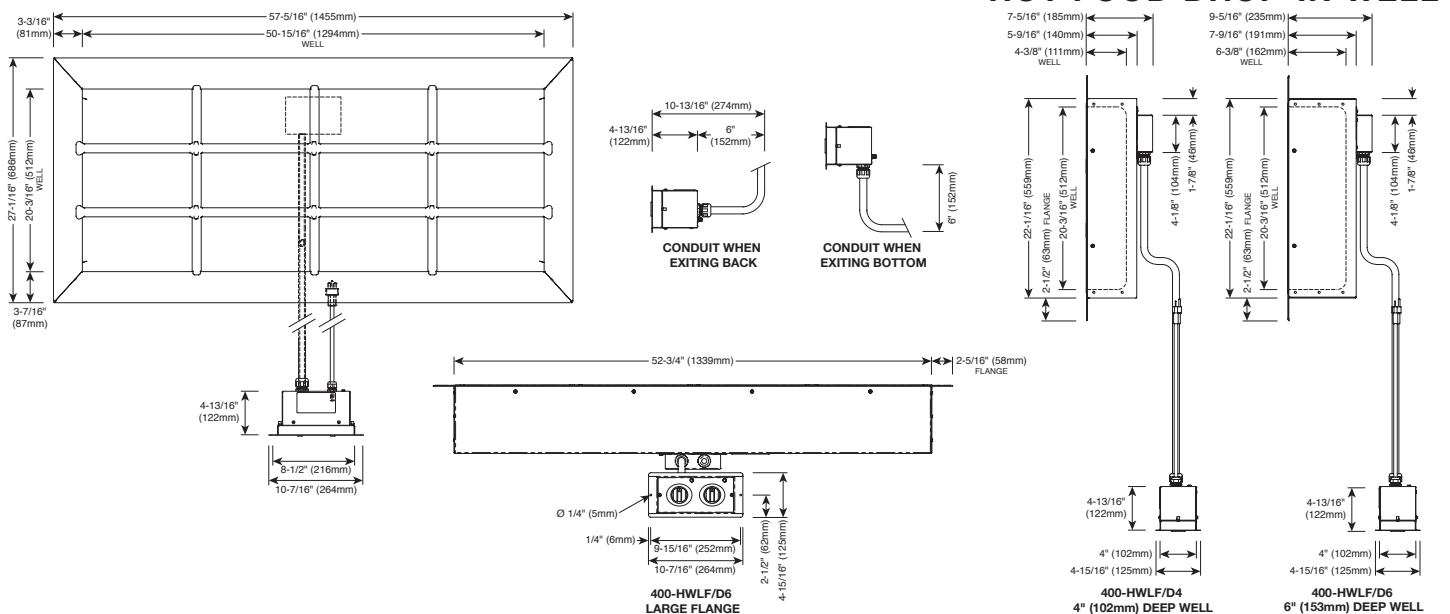

400-HWI SERIES



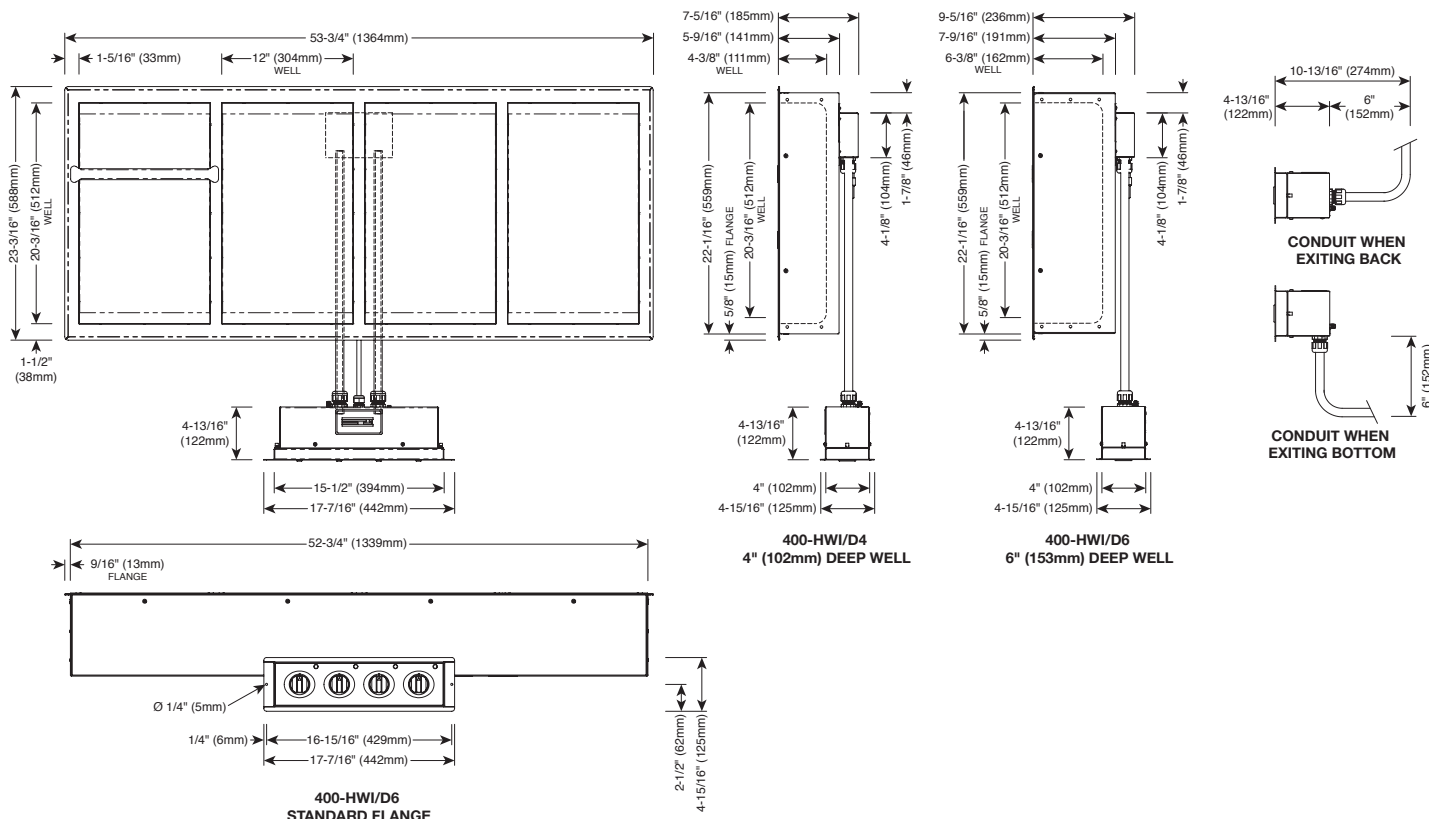

HOT FOOD DROP-IN WELL

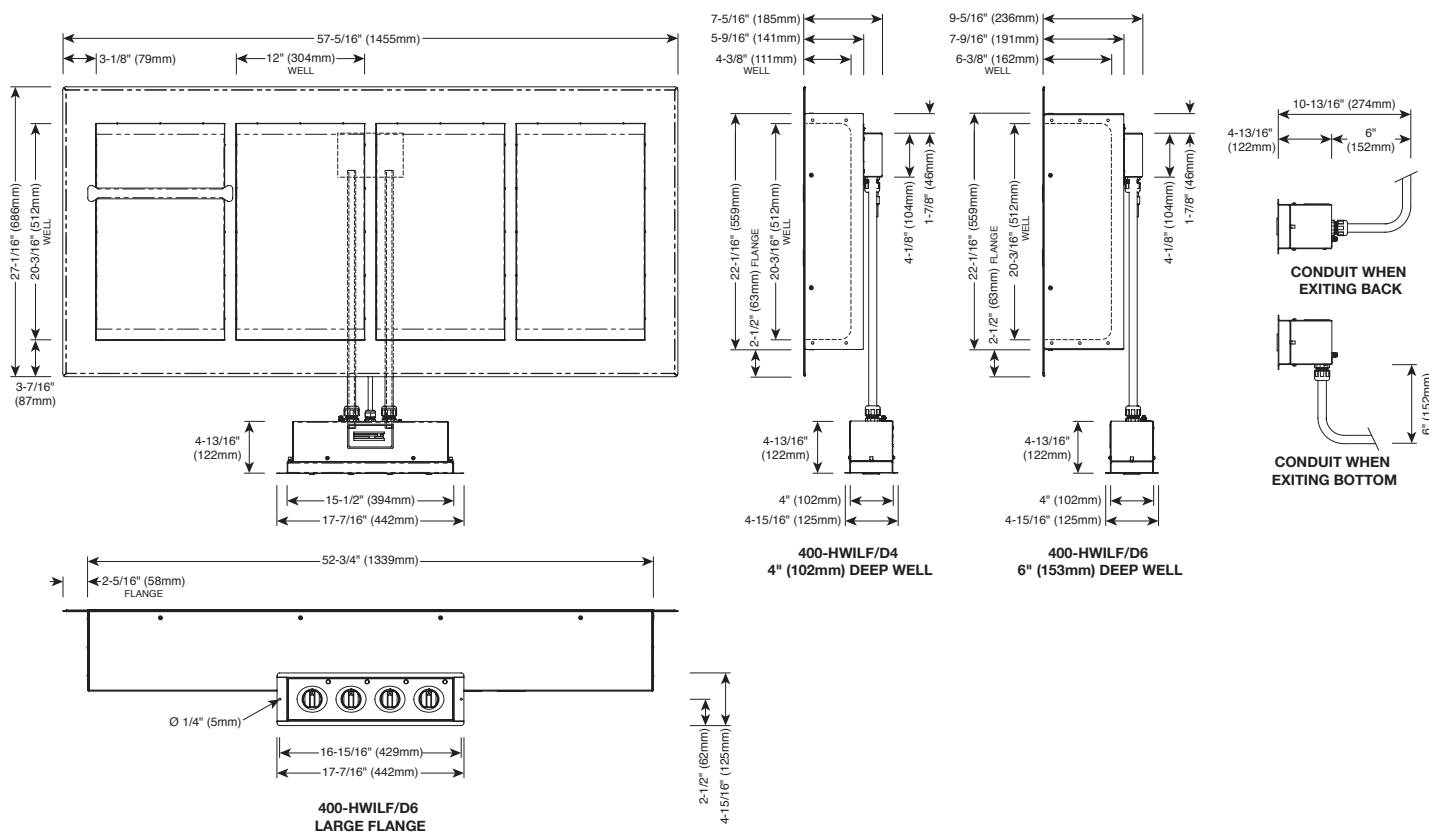

400-HWILF SERIES

HOT FOOD DROP-IN WELL



ELECTRICAL:											
400-HW/D4 & /D6, 400-HWLF/D4 & /D6, 400-HWI/D4 & /D6, 400-HWILF/D4 & /D6	VOLTAGE	PHASE	CYCLE/HZ	AMPS	kw	PLUG CONFIGURATION					
	120	1	50/60	20.0	2.4	 NEMA L5-30P 30A - 125V PLUG					
	208 - 240	1	50/60	8.7 - 10.0	1.8 - 2.4	 NEMA 6-15P 15A - 250V PLUG					
	230	1	50/60	10.4	2.4	 CEE 7/7 PLUG RATED 250V	 CH2-16P PLUG RATED 250V	 BS1363 PLUG RATED 250V			

DIMENSIONS:											
	OVERALL EXTERIOR			WELL INTERIOR			COUNTER CUTOUT		CONTROL BOX CUTOUT		
	HEIGHT	WIDTH	DEPTH	HEIGHT	WIDTH	DEPTH	WIDTH	DEPTH	HEIGHT	WIDTH	DEPTH
400-HW/D4	7-5/16" (185mm)	54" (1371mm)	23-1/8" (586mm)	4-3/8" (111mm)	50-15/16" (1294mm)	20-3/16" (512mm)	53-1/8" (1350mm)	22-1/2" (572mm)	4-1/4" (108mm)	8-3/4" (222mm)	10-13/16" (274mm)
400-HW/D6	9-5/16" (235mm)	54" (1371mm)	23-1/8" (586mm)	6-3/8" (162mm)	50-15/16" (1294mm)	20-3/16" (512mm)	53-1/8" (1350mm)	22-1/2" (572mm)	4-1/4" (108mm)	8-3/4" (222mm)	10-13/16" (274mm)
400-HWLF/D4	7-5/16" (185mm)	57-5/16" (1455mm)	27-1/16" (686mm)	4-3/8" (111mm)	50-15/16" (1294mm)	20-3/16" (512mm)	53-1/8" (1350mm)	22-1/2" (572mm)	4-1/4" (108mm)	8-3/4" (222mm)	10-13/16" (274mm)
400-HWLF/D6	9-5/16" (235mm)	57-5/16" (1455mm)	27-1/16" (686mm)	6-3/8" (162mm)	50-15/16" (1294mm)	20-3/16" (512mm)	53-1/8" (1350mm)	22-1/2" (572mm)	4-1/4" (108mm)	8-3/4" (222mm)	10-13/16" (274mm)
400-HWI/D4	7-5/16" (185mm)	53-3/4" (1364mm)	23-3/16" (588mm)	4-3/8" (111mm)	12" (304mm)	20-3/16" (512mm)	53-1/8" (1350mm)	22-1/2" (572mm)	4-1/4" (108mm)	15-3/4" (400mm)	10-13/16" (274mm)
400-HWI/D6	9-5/16" (236mm)	53-3/4" (1364mm)	23-3/16" (588mm)	6-3/8" (162mm)	12" (304mm)	20-3/16" (512mm)	53-1/8" (1350mm)	22-1/2" (572mm)	4-1/4" (108mm)	15-3/4" (400mm)	10-13/16" (274mm)
400-HWILF/D4	7-5/16" (185mm)	57-5/16" (1455mm)	27-1/16" (686mm)	4-3/8" (111mm)	12" (304mm)	20-3/16" (512mm)	53-1/8" (1350mm)	22-1/2" (572mm)	4-1/4" (108mm)	15-3/4" (400mm)	10-13/16" (274mm)
400-HWILF/D6	9-5/16" (238mm)	57-5/16" (1455mm)	27-1/16" (686mm)	6-3/8" (162mm)	12" (304mm)	20-3/16" (512mm)	53-1/8" (1350mm)	22-1/2" (572mm)	4-1/4" (108mm)	15-3/4" (400mm)	10-13/16" (274mm)

*Allow 6" (152mm) clearance from control box to conduit bend

WEIGHT: EST.			
	NET WEIGHT	SHIP WEIGHT*	CRATE DIMENSIONS* L X W X H
400-HW/D4	71 lb (32 kg)	115 lb (52 kg)	60" x 34" x 15" (1524 x 864 x 381mm)
400-HW/D6	79 lb (36 kg)	146 lb (66 kg)	60" x 34" x 15" (1524 x 864 x 381mm)
400-HWLF/D4	75 lb (34 kg)	CONTACT FACTORY	60" x 34" x 15" (1524 x 864 x 381mm)
400-HWLF/D6	83 lb (38 kg)	CONTACT FACTORY	60" x 34" x 15" (1524 x 864 x 381mm)
400-HWI/D4	90 lb (41 kg)	CONTACT FACTORY	60" x 34" x 15" (1524 x 864 x 381mm)
400-HWI/D6	101.5 lb (46 kg)	CONTACT FACTORY	60" x 34" x 15" (1524 x 864 x 381mm)
400-HWILF/D4	96.5 lb (44 kg)	CONTACT FACTORY	60" x 34" x 15" (1524 x 864 x 381mm)
400-HWILF/D6	108 lb (49 kg)	CONTACT FACTORY	60" x 34" x 15" (1524 x 864 x 381mm)

*DOMESTIC GROUND SHIPPING INFORMATION. CONTACT FACTORY FOR EXPORT WEIGHT AND DIMENSIONS.

