

Stainless Steel Models: SFT-31 SFT-45 SFT-59 SFT-73 SFT-87

Granite Models: GFT-31 GFT-45 GFT-59 GFT-73 GFT-87

PRODUCT:

QUANTITY:

ITEM:

Designed Smart

The Drop-in Self Contained Frost Tops are insulated with high density polyurethane foam making them ideal for product demonstration while maintaining product temperatures. Available in Stainless Steel or Granite.

APW Wyott Design Features

Stainless Steel Models

- Stainless steel construction
- Raised top with full perimeter drain trough and 1/2" drain
- Environmentally friendly HFC-404A refrigerant
- Drop-in Design
- NSF Certified
- On/Off power
- Push in perimeter gasket standard
- Stainless steel louver provided

Granite Models

- "Absolute Black Granite" granite top on 14-gauge stainless steel
- Thermal mastic heat transfer compound between granite and stainless steel
- Environmentally friendly HFC-404A refrigerant
- Drop-in Design
- NSF Certified
- On/Off power
- Stainless steel louver provided

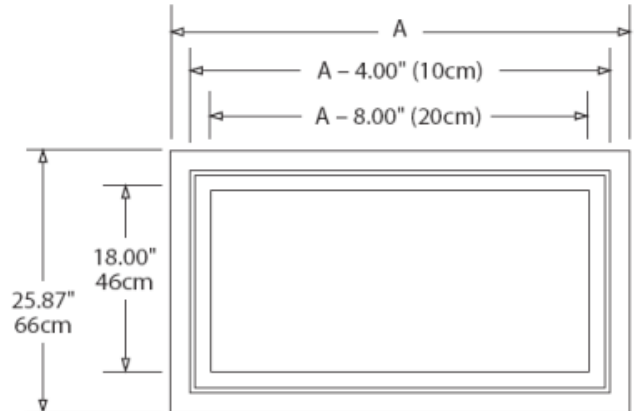

Reliability Backed by APW Wyott's Warranty

1-year parts and labor warranty, including on-site service calls within 50 miles of authorized service technicians.

Certified by the following agencies:



Stainless Steel Models: SFT-31 SFT-45 SFT-59 SFT-73 SFT-87

Granite Models: GFT-31 GFT-45 GFT-59 GFT-73 GFT-87

PRODUCT:

QUANTITY:

ITEM:

Product Specifications: Stainless Steel Models

Model	Cut Out Dimensions	Length	V/Hz/Ph	Amps	H.P.	Weight
SFT-31	30.75" X 25" (78CM X 64CM)	31.75"	115/60/1	7.5	1/4	142 Lbs
SFT-45	44.63" X 25" (113CM X 64CM)	45.63"	115/60/1	7.5	1/4	168 Lbs
SFT-59	58.5" X 25" (149CM X 64CM)	59.5"	115/60/1	7.5	1/4	193 Lbs
SFT-73	72.38" X 25" (184CM X 64CM)	73.38"	115/60/1	8	1/3	209 Lbs
SFT-87	86.25" X 25" (219CM X 64CM)	87.25"	115/60/1	8	1/3	239 Lbs

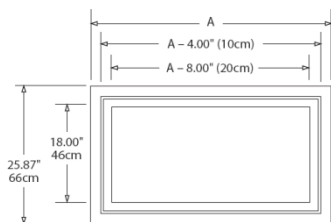

Plain View

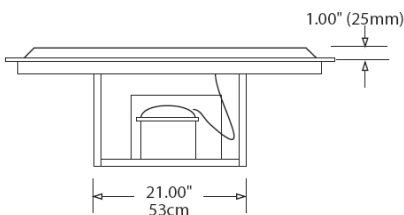

Elevation View

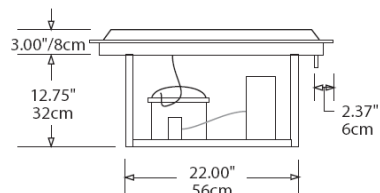

Right End View

Product Specifications: Granite Models

Model	Cut Out Dimensions	Nema Plug	V/Hz/Ph	Amps	H.P.	Weight
GFT-31	30.75" X 25" (78CM X 64CM)	5-15P	115/60/1	7	1/4	220 Lbs
GFT-45	44.63" X 25" (113CM X 64CM)	5-15P	115/60/1	7	1/4	288 Lbs
GFT-59	58.5" X 25" (149CM X 64CM)	5-15P	115/60/1	8	1/3	336 Lbs
GFT-73	72.38" X 25" (184CM X 64CM)	5-15P	115/60/1	9	1/2	424 Lbs

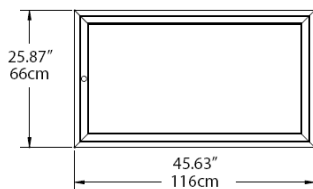

Plain View

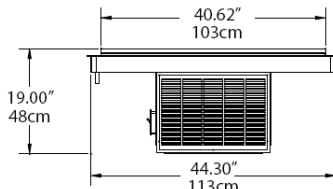

Elevation View

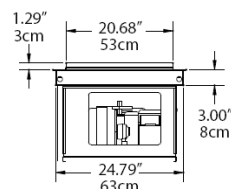

Right End View

FOB: Tennessee, 38372

*APW Wyott reserves the right to modify specifications or discontinue models without incurring obligation.