



Redefining Healthcare Food Service

With Alluserv you are not just buying a product. You are receiving our team's service commitment to get the most value from your investment in our products. We will provide you with:

- A team of knowledgeable experts with over 100 years of combined experience to help you understand and receive the most from your product throughout its service life
- Detailed instructions and specification on cleaning and application to best maintain your equipment
- A national service network and service manuals for our extensive product offering.

DRYING RACKS

APPLICATION

The Alluserv drying rack can support any tray line layout. These drying racks are designed to provide a convenient and organized method of drying and storing domes and induction bases as well as those induction bases for meal assembly. Depending on your bed count requirements, we offer the drying rack with capacities of 60 and 100 for the domes and 108 and 180 for induction bases. Cradles are removable and can run thru dish washing machines.

CONSTRUCTION

The rigid frame is constructed of 1" O.D. square 18-gauge stainless steel tubular uprights and 14-gauge stainless steel "L" shape supports. The all welded construction makes this drying rack strong, durable and reliable. The unit maneuvers easily on four 5" diameter swivel casters with non-marking cushion tread, two with brakes to secure unit's position when necessary.

Drying Racks

Model Numbers:

Domes: 60CDR, 100CDR

Induction Bases: 108CDR, 180CDR

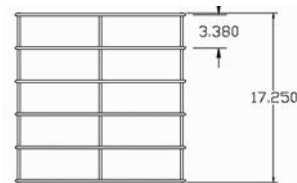

Dome Cradle

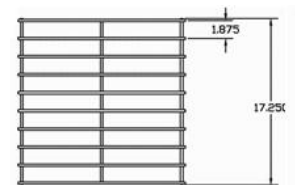

Induction Base Cradle

Warranty

- Two years parts and one year labor

Drying Racks

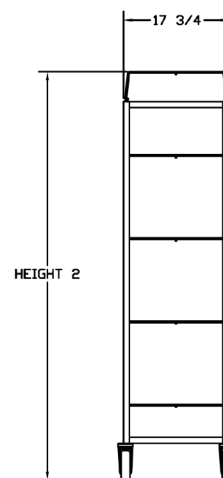
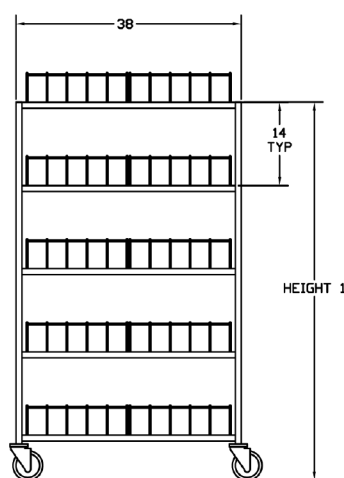
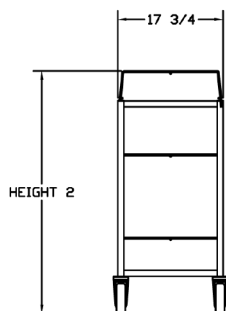
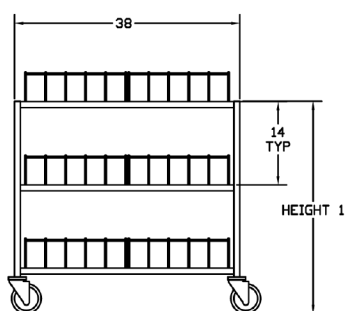
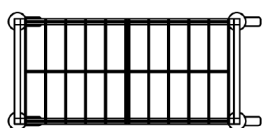

DIMENSIONS

MODEL	OVERALL SIZE			TRAY CAPACITY	CASE WEIGHT
	D	L	H		
60CDR	20-1/4"	39-1/4"	35-5/8"	60	81
100CDR	20-1/4"	39-1/4"	68-5/8"	100	117
108CDR	20-1/4"	39-1/4"	35-5/8"	108	90
180CDR	20-1/4"	39-1/4"	68-5/8"	180	125



901 West 14th Street | Suite 200 | Washington, MO | 63090 | toll free 888-892-2213 | fax 636-239-8435 | alluserv.com