



# BEVERAGE-AIR

3779 Champion Blvd., Winston-Salem, NC 27105  
1-888-845-9800 Fax# 1-336-245-6453  
<http://www.Beverage-Air.com>

**CUSTOMER'S CHOICE FOR A *HOT* LOCATION**  
**Tested & Certified to Ambient Class of 100°F**

**3 Year Parts/Labor Warranty**  
**Additional 2 Year Compressor Warranty**

### BB24 SERIES—BACK BAR REFRIGERATOR

Depth is 29 1/2" from face of door to back of cabinet. Handle projects 1/2." Solid door models come standard with locks. Glass door models available (BB24G-1-B, BB24G-1-S).

### CABINET CONSTRUCTION

Standard, cabinet exterior construction includes attractive, wear resistant vinyl on steel in black exterior finish. Door is self-closing and includes magnetic gaskets for positive seal.

Standard interior construction utilizes galvanized steel walls and ceiling. Reinforced floor and door sills are made from heavy-duty stainless steel to provide long lasting service. Interior, incandescent, lighting is standard with manual on/off switch. Glass door models feature fluorescent lighting.

Four-inch (4") heavy-duty casters are standard.

**Note:** Unit standard on casters. It is not possible to order without casters.

Foamed-in-place CFC and HCFC-free polyurethane insulation enhances the structural strength of the cabinet and helps increase energy efficiency.

### REFRIGERATION

Refrigeration system uses R134a refrigerant, which is CFC and HCFC-free for compliance with environmental safety concerns.

### ELECTRICAL

Units wired at factory and ready for connection to a 115/60/1 phase, 15 amp dedicated outlet. 8' long cord and plug set included.

### SPECIAL FEATURES

- Keg storage is maximized in lieu of shelf storage when required.

Item No. \_\_\_\_\_  
Quantity \_\_\_\_\_

**BEER EQUIPMENT  
BACK BAR  
REFRIGERATOR  
BB24 SERIES**

**MODELS:  
BB24-1-B  
BB24-1-S  
BB24G-1-B  
BB24G-1-S**

**NOTE:** Unit standard on casters. It is not possible to order without casters.



**BB24** (black exterior with solid door shown)

**Finishes available:** Black (-B) or S/S (-S)  
**Door options:** Solid or Glass Doors (G)



\*Note: Not all markings may apply to all model variations.

Available From:

<b>Model Specified</b> _____	<b>Store#</b> _____
<b>Location</b> _____	<b>Quantity</b> _____



**Back Bar Refrigerators**  
**Model: BB24**

**PLAN VIEWS**

MODEL	BB24
<b>EXTERNAL DIMENSIONAL DATA</b>	
Length Overall (inches)	24"
Length Overall (mm)	610
Depth Overall (inches)	29 1/2"
Depth Overall (mm)	749
Height Overall— (inches)	37 3/4"
Height Overall—(mm)	959
Clear Door Width (inches)	14 5/8" x 8 1/2"
Depth With Door Open 90°	48"
Number of doors	1
<b>INTERNAL DIMENSIONAL DATA</b>	
NET Capacity (cubic ft.)	7.8
NET Capacity (Liters)	221
Internal Length Overall (inches)	19"
Internal Length Overall (mm)	483
Internal Depth Overall (inches)	23 3/4"
Internal Depth Overall (mm)	603
Internal Height Overall (inches)	29 1/2"
Internal Height Overall (mm)	749
Number of Kegs (straight wall)	1
<b>ELECTRICAL DATA</b>	
Full Load Amperes 115/60/1	4
<b>REFRIGERATION DATA</b>	
Horsepower	1/5
<b>WEIGHT DATA</b>	
Gross Weight (Crated lbs)	180
Gross Weight (Crated kg)	82

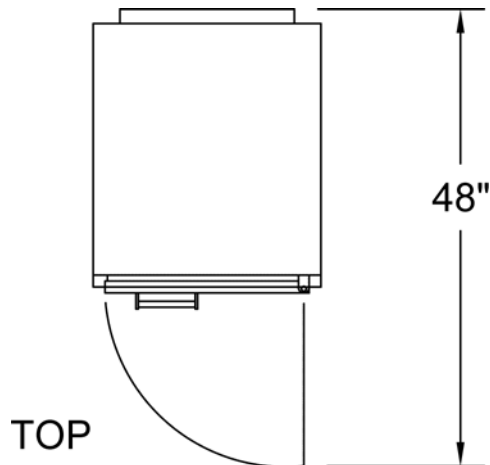
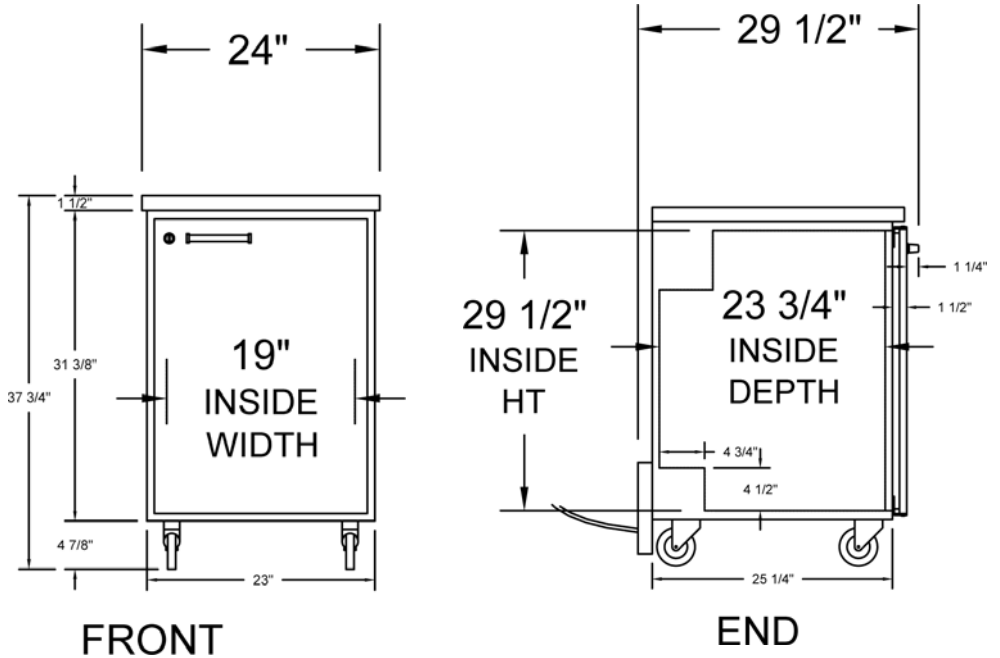

\*Note: Not all markings may apply to all model variations.

**ELECTRICAL CONNECTION**

Units pre-wired at factory and include 8' long cord and plug set.



**BEVERAGE-AIR® CORPORATION**

3779 Champion Blvd. • Winston-Salem, NC 27105 USA • (336) 245-6400 • Fax (336) 245-6453 • (888) 845-9800 • www.beverage-air.com

Specifications are subject to change without prior notice. 06/13