

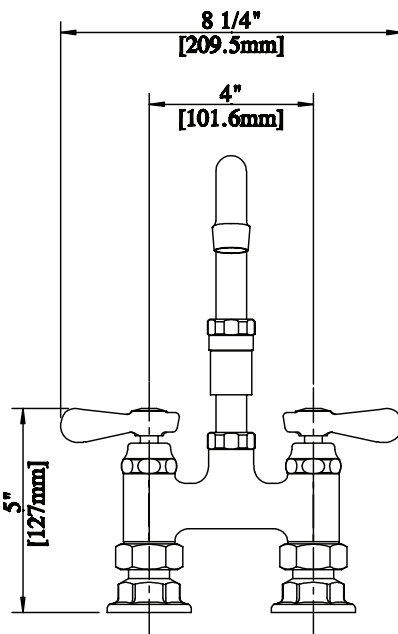

Use your smart phone to scan the above QR code to visit our website: www.bk-resources.com

4" Deck Mount Heavy Duty Faucet with DJ Swing Spout

Model: BKF4HD-18-G, Lead Free

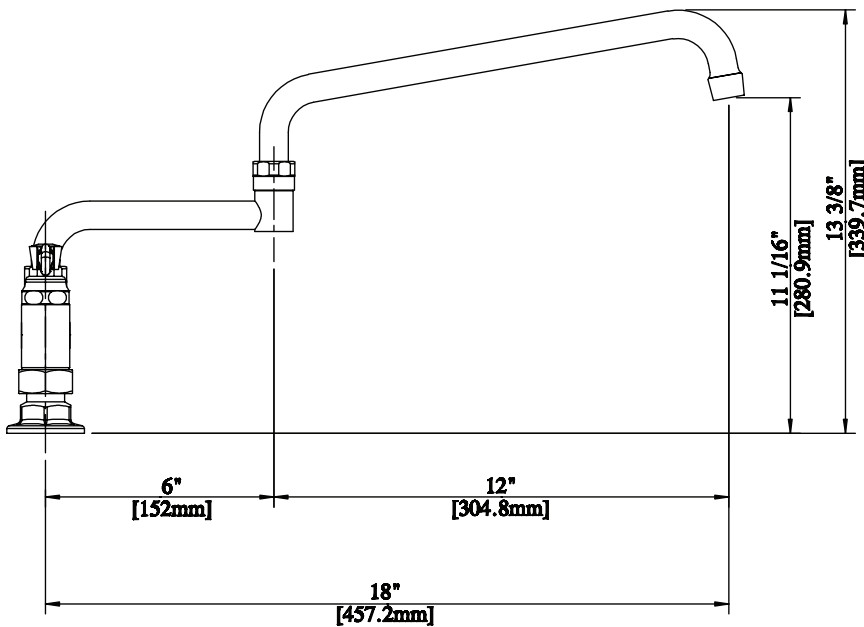
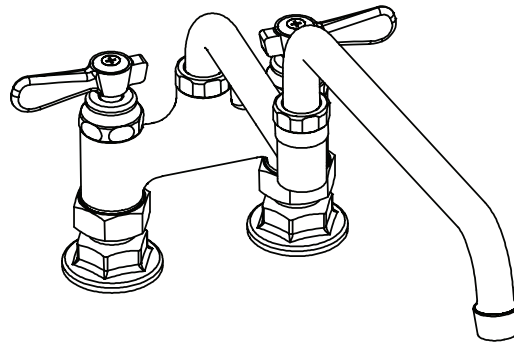

Options:



BKF-C414-VR
Vandal Resistant Aerator - .5 GPM



BKF-WBH
ADA Compliant
Wrist Blade Handles

BK-DMMK
Faucet Mounting Kit - *SOLD SEPARATELY*

Product Specifications:

- Heavy Duty Double Seat 1/4 Turn Ceramic Cartridges
- Color Coded Hot & Cold Indicators
- Double O-Ring Spout Seal
- High Polished Triple Dipped Chrome Finish
- Integral Check Valve
- Lead Free Compliant
- Full Replacement Parts Available

Certifications:



PRODUCT SPECIFICATION SHEET

RESOURCES





4" Deck Mount Heavy Duty Faucet with DJ Swing Spout



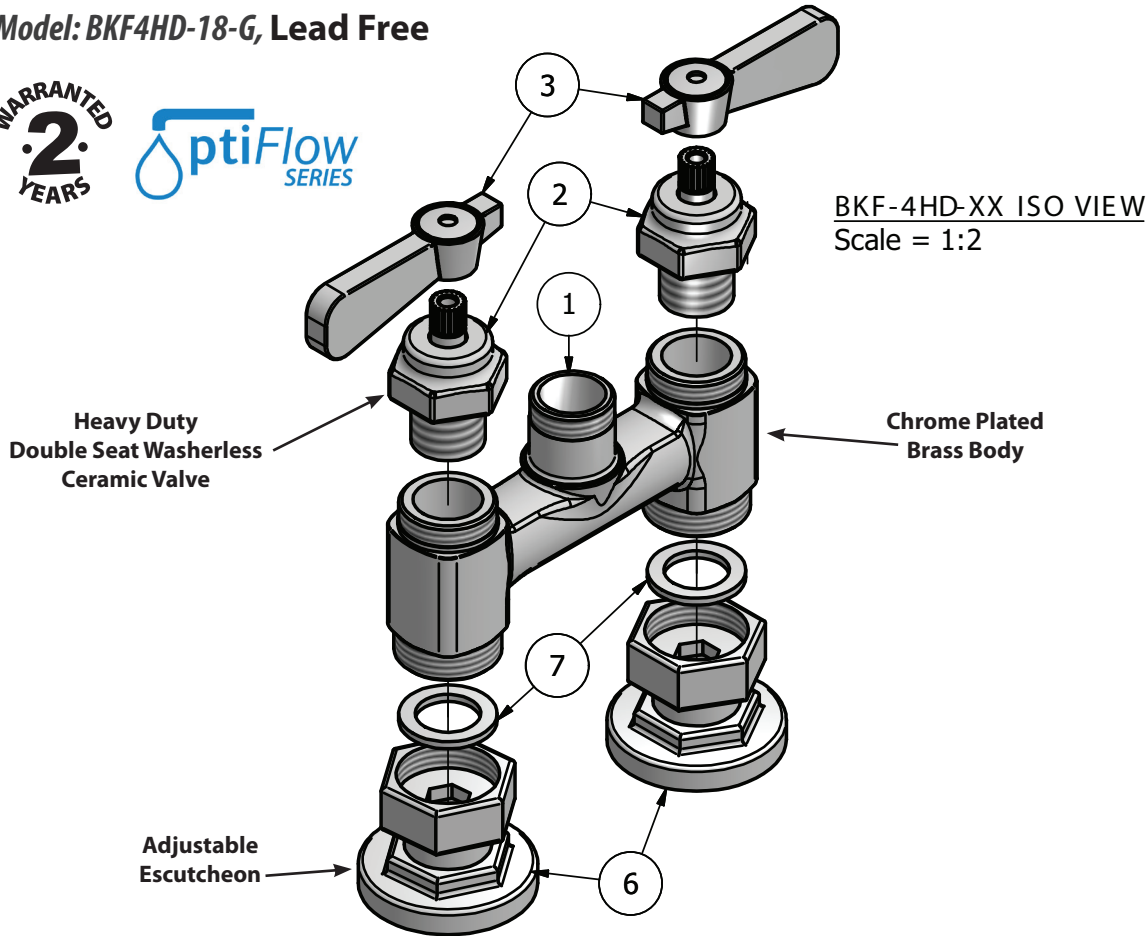

Model: BKF4HD-18-G, Lead Free



Exploded Parts Detail:

Diagram #	Quantity	Part Number	Description
1	1	BKF4HD-XX	Faucet Body
2	2	BKF-HV/CV	Cartridge Assembly
3	2	BKF-SBH	Handle
6	2	BKF-ESC	Mixing Valve Mounting Nut
7	2	BKF-ESC-WASHER	Washer

Optional Spouts & Parts:

-  Heavy Duty Gooseneck Spout
BKF-HSPT-3G-G, BKF-HSPT-5G-G
BKF-HSPT-8G-G
-  Heavy Duty DJ Swing Spout
BKF-HSPT-18-G
-  Heavy Duty Swing Spout
BKF-HSPT-6-G, BKF-HSPT-8-G
BKF-HSPT-10-G, BKF-HSPT-12-G
BKF-HSPT-14-G, BKF-HSPT-16-G
-  BKF-C414-VR
Vandal Resistant Aerator - .5 GPM
-  BKF-WBH
ADA Compliant
Wrist Blade Handles

BK-DMMK
Faucet Mounting Kit - SOLD SEPARATELY

PRODUCT SPECIFICATION SHEET

RESOURCES

