

DESIGNER LINE SANDWICH UNIT

Model: DL48-8-D

48" Standard Top Sandwich Unit Refrigerator with Drawers - 8 Pans

Stainless steel exterior and interior.
 Certified under NSF-7 to maintain temperatures in 86°F ambient and designed to maintain NSF-7 temperatures in 100°F ambient.



Options and Accessories

(upcharge and lead times may apply)

Stainless steel finished back in lieu of aluminum	Flat insulated night cover
Overshelves (single or double)	Remote models
Solid doors in lieu of drawers	Drawer locks
Automatic, electric condensate evaporator	Crumb catcher
Modified pan openings	Top extensions
Front breathing	Digital thermometer
Expansion valve system	Casters
Rear-mounted cutting board	Three tier drawers

Consult factory for other model configurations, options and accessories.

Continental
 Refrigerator

Toll-Free: 800-523-7138
 Phone: 215-244-1400
 Fax: 215-244-9579

539 Dunksferry Road
 Bensalem, PA 19020
www.continentalrefrigerator.com

Project Name:

Model Specified:

Location:

Item No:

Quantity:

AIA #:

SIS #:

Standard Model Features

REFRIGERATION SYSTEM

- Performance-rated refrigeration system
- Environmentally-safe R-134a refrigerant
- Unique air flow distribution allows pan product to maintain 33° - 41°F
- Automatic, energy saving, non-electric condensate evaporator
- Non-corrosive, plasticized fin evaporator coil
- Easily serviceable, back mounted compressor

CABINET ARCHITECTURE

- 2" non-CFC polyurethane foam insulation
- Magnetic snap-in drawer gaskets
- 12" deep, full length nylon cutting board
- Stainless steel roll-out drawers
- Insulated lid
- Adjustable 6" stainless steel legs
- Completely enclosed, vented and removable case back

MODEL FEATURES

- (8) 1/6 size non-recessed pans, 4" deep
- Interior hanging thermometer

APPROVAL:

Model Specifications

DIMENSIONAL DATA

Net Capacity (cu. ft.)	13.4 (379 cu l)
1/6 Size Pans (4" deep)	8
Width, Overall (in.)	48 (1219 mm)
Depth, Overall (in.) (incl. handles & bumpers)	31 7/16 (799 mm)
Depth, Body Only (in.) (less drawers)	27 1/2 (699 mm)
Depth, Cutting Board (in.)	12 (305 mm)
Height, Overall (in.) (incl. 6" legs)	43 1/4 (1099 mm)
No. of Drawers (two tier)	4
No. of Drawers (three tier)	6

REFRIGERANT DATA

Condensing Unit Size (H.P.)	1/5
Capacity (BTU/Hr)*	1620

ELECTRICAL DATA

Voltage (int'l)	115/60/1 (220/50/1)
Fans	3
Total Amps (int'l)	7.3 (3.6)
10 ft. Cord/Plug [attached] (int'l)	Yes (No)

SHIPPING DATA

Weight (lbs.)	267 (121 kg)
Height - Crated (in.)	43 1/4 (1099 mm)
Width - Crated (in.)	64 (1626 mm)
Depth - Crated (in.)	46 (1168 mm)

DRAWER PAN CONFIGURATIONS

Two Tier: (1) 12 x 18 x 6 pan per drawer
or (1) 1/2 size x 6 & (1) 1/3 x 6 pans per drawer

Three Tier: (1) 12 x 18 x 3 1/2 pan per drawer
or (1) 1/2 size x 4 & (1) 1/3 x 4 pans per drawer

* Rating @ +25°F evaporator, 90°F ambient

Figures in parentheses reflect metric equivalents rounded to the nearest whole unit.



Equipped with one NEMA-5-15P Plug
(varies by country)

Continental

Refrigerator

Toll-Free: 800-523-7138
Phone: 215-244-1400
Fax: 215-244-9579

539 Dunksferry Road
Bensalem, PA 19020
www.continentalrefrigerator.com

Due to our continued efforts in developing innovative products, specifications subject to change without notice.



Intertek



MADE IN THE U.S.A.

© Copyright 2015, Continental Refrigerator.
A Division of National Refrigeration & Air Conditioning Products, Inc.

Model Plan Views

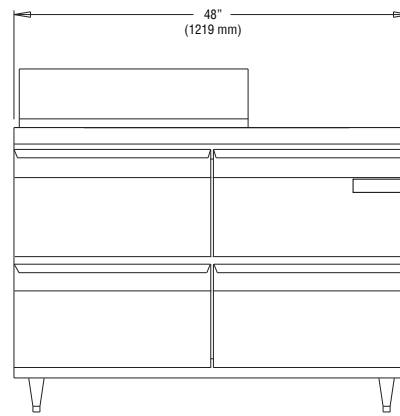

FRONT VIEW

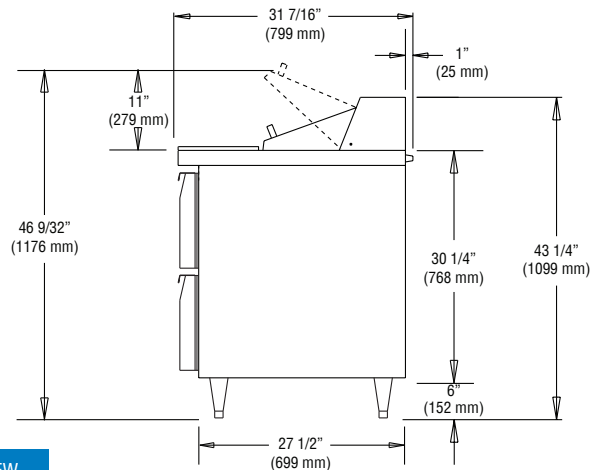

SIDE VIEW

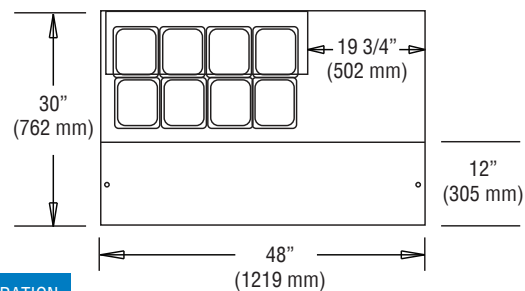

PAN TOP CONFIGURATION

Note: Shown with two tier drawers, see **Standard Design Features** for drawer pan configurations.

REFRIGERATION SYSTEM

Self-contained refrigeration system is rear mounted, concealed behind a removable louvered cover. A "performancerated", air-cooled, hermetically sealed, capillary type refrigeration system is installed in model. Plasticized finned coil and air circulating fans are contained within an easily accessible rear mounted housing. Unique airflow design allows the cabinet to be enclosed on both sides or mounted flush against a wall. Refrigeration system, fully charged with R-134a refrigerant, is designed to maintain 38°-41°F while operating with an unrestricted air supply in an ambient temperature of 100°F. All condensate water is directed to a non-electric condensate vaporizer located in the compressor compartment, no plumbing is required. A strict quality assurance team inspects all materials and components to certify the model conforms to the most exacting standards. Model is performance tested for a minimum of 16 hours prior to crating.

INSULATION

All cabinet walls, top and bottom have high density, foamed-in-place, non-CFC polyurethane insulation.

CABINET CONSTRUCTION

Materials are top quality, assembled under rigid supervision conforming to strict quality assurance requirements. Case is welded metal construction, internally supported and braced for rigid unit construction. Exterior, interior and worktop are heavy gauge polished stainless steel. Design eliminates overlapping panels with raw edges. Interior corners are rounded with 1/4" radius. Joints and seams are vapor-tight sealed. Easily removable anti-sweat door heaters, concealed by non-metallic, non-conductive, high impact thermal breaker strips, eliminates condensation build-up on case front.

DRAWER CONSTRUCTION

Fronts/back are constructed of heavy-gauge, polished stainless steel with heavy-duty, safety grip, chrome plated handles. Drawer fronts are insulated with non-CFC polyurethane foam insulation. Full extension, lift-out frames are heavy gauge, welded stainless steel mounted on heavy-duty, easy glide, self closing slides. Self adjusting, full perimeter, magnetic snap-in gaskets guarantee a positive seal.