

SANDWICH UNIT REFRIGERATOR

Model: SW36-8C-FB

36" Cutting Top Sandwich Unit Refrigerator with Solid Doors - 8 Pans Front Breathing

Stainless steel front and top, aluminum end panels, case back and interior.
Certified under NSF-7 to maintain temperatures in 86°F ambient and designed to maintain NSF-7 temperatures in 100°F ambient.



Options and Accessories

(upcharge and lead times may apply)

Stainless steel exterior and interior - SS models	Drawers in lieu of doors
Stainless steel end panels - SA models	Stainless steel shelves
Glass doors in lieu of solid doors - GD models	Expansion valve system
Stainless steel finished back in lieu of aluminum	Rear-mounted cutting board
Overshelves (single or double)	Flat insulated night cover
Additional epoxy-coated steel shelves	Remote models
Automatic, electric condensate evaporator	Door locks

Consult factory for other model configurations, options and accessories.

Project Name:

Model Specified:

Location:

Item No:

Quantity:

AIA #:

SIS #:

Standard Model Features

REFRIGERATION SYSTEM

- Performance-rated refrigeration system
- Environmentally-safe R-134a refrigerant
- Unique air flow distribution allows pan product to maintain 33° - 41°F
- Automatic, energy saving, non-electric condensate evaporator
- Non-corrosive, plasticized fin evaporator coil
- Easily serviceable, back mounted compressor

CABINET ARCHITECTURE

- 2" non-CFC polyurethane foam insulation
- Spring loaded, self closing doors
- Magnetic snap-in door gaskets
- Heavy-duty, epoxy-coated steel shelves
- 19" deep, full length nylon cutting board
- Insulated lid
- 3 5/8" casters
- Completely enclosed, vented and removable case back

MODEL FEATURES

- (8) 1/6 size non-recessed pans, 4" deep
- Interior hanging thermometer
- Field rehingeable doors

Front breathers are a unique, field assembled, bottom mounted ventilation system designed to allow cabinets to be flush against a wall or built into a counter to conserve space.

Continental
 Refrigerator

Toll-Free: 800-523-7138
 Phone: 215-244-1400
 Fax: 215-244-9579

539 Dunksferry Road
 Bensalem, PA 19020
www.continentalrefrigerator.com

APPROVAL:

Model Specifications

DIMENSIONAL DATA

Net Capacity (cu. ft.)	10.3 (292 cu l)
1/6 Size Pans (4" deep)	8
Width, Overall (in.)	36 (914 mm)
Depth, Overall (in.) (incl. cutting board & bumpers)	38 1/4 (972 mm)
Depth, Body Only (less doors) (in.)	27 1/2 (699 mm)
Depth, Cutting Board (in.)	19 (483 mm)
Height, Overall (in.) (incl. 3 5/8" casters)	40 7/8 (1038 mm)
Shelf Area (sq. ft.)	4.6 (.4 sq m)
No. of Shelves	2
No. of Doors	2
Interior Depth (in.)	19 3/8 (492 mm)
Interior Height (in.)	26 1/4 (667 mm)
Interior Width (in.)	32 (813 mm)

REFRIGERANT DATA

Condensing Unit Size (H.P.)	1/5
Capacity (BTU/Hr)*	1620

ELECTRICAL DATA

Voltage (int'l)	115/60/1 (220/50/1)
Fans	2
Total Amps (int'l)	6.3 (3.7)
10 ft. Cord/Plug [attached] (int'l)	Yes (No)

SHIPPING DATA

Weight (lbs.)	240 (109 kg)
Height - Crated (in.)	43 1/4 (1099 mm)
Width - Crated (in.)	43 (1092 mm)
Depth - Crated (in.)	46 (1168 mm)

* Rating @ +25°F evaporator, 90°F ambient
 Figures in parentheses reflect metric equivalents rounded to the nearest whole unit.



Equipped with one NEMA-5-15P Plug
 (varies by country)

Continental

Refrigerator

Toll-Free: 800-523-7138
 Phone: 215-244-1400
 Fax: 215-244-9579

539 Dunkserry Road
 Bensalem, PA 19020
www.continentalrefrigerator.com

Due to our continued efforts in developing innovative products, specifications subject to change without notice.



© Copyright 2013. Continental Refrigerator.
 A Division of National Refrigeration & Air Conditioning Products, Inc.

Model Plan Views

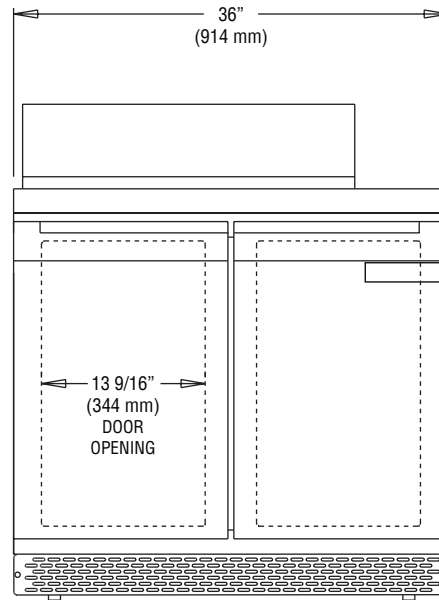

FRONT VIEW

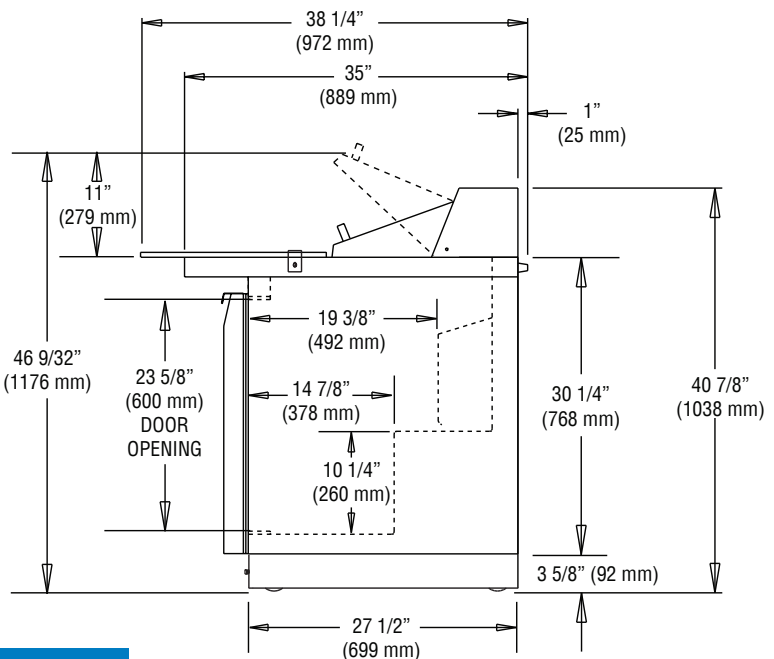

SIDE VIEW

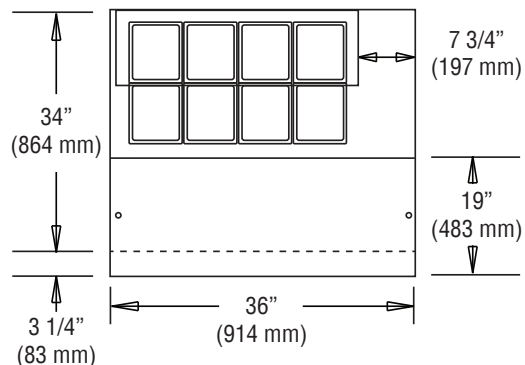

PAN TOP CONFIGURATION