

# SANDWICH UNIT REFRIGERATOR

**Model: SW60-16C-D**

## 60" Cutting Top Sandwich Unit Refrigerator with Drawers - 16 Pans

Stainless steel front and top, aluminum end panels, case back and interior.  
**Certified under NSF-7 to maintain temperatures in 86°F ambient and designed to maintain NSF-7 temperatures in 100°F ambient.**



### Options and Accessories

(upcharge and lead times may apply)

Stainless steel exterior and interior - SS models	Expansion valve system
Stainless steel end panels - SA models	Rear-mounted cutting board
Glass doors in lieu of drawers - GD models	Flat insulated night cover
Stainless steel finished back in lieu of aluminum	Remote models
Solid doors in lieu of drawers	Drawer locks
Overshelves (single or double)	Adjustable legs
Automatic, electric condensate evaporator	Three tier drawers

Consult factory for other model configurations, options and accessories.

Project Name:

Model Specified:

Location:

Item No:

Quantity:

AIA #:

SIS #:

### Standard Model Features

#### REFRIGERATION SYSTEM

- Performance-rated refrigeration system
- Environmentally-safe R-134a refrigerant
- Unique air flow distribution allows pan product to maintain 33° - 41°F
- Automatic, energy saving, non-electric condensate evaporator
- Non-corrosive, plasticized fin evaporator coil
- Easily serviceable, back mounted compressor

#### CABINET ARCHITECTURE

- 2" non-CFC polyurethane foam insulation
- Magnetic snap-in drawer gaskets
- 19" deep, full length nylon cutting board
- Stainless steel roll-out drawers
- Insulated lid
- 5" casters
- Completely enclosed, vented and removable case back

#### MODEL FEATURES

- (16) 1/6 size non-recessed pans, 4" deep
- Interior hanging thermometer

**Continental**  
 Refrigerator

Toll-Free: 800-523-7138  
 Phone: 215-244-1400  
 Fax: 215-244-9579

539 Dunksferry Road  
 Bensalem, PA 19020  
[www.continentalrefrigerator.com](http://www.continentalrefrigerator.com)

APPROVAL:

## Model Specifications

### DIMENSIONAL DATA

Net Capacity (cu. ft.)	17.0 (481 cu l)
1/6 Size Pans (4" deep)	16
Width, Overall (in.)	60 (1524 mm)
Depth, Overall (in.) (incl. cutting board & bumpers)	38 1/4 (972 mm)
Depth, Body Only (less drawers) (in.)	27 1/2 (699 mm)
Depth, Cutting Board (in.)	19 (483 mm)
Height, Overall (in.) (incl. 5" casters)	42 1/4 (1073 mm)
No. of Drawers (two tier)	4
No. of Drawers (three tier)	6

### REFRIGERANT DATA

Condensing Unit Size (H.P.)	1/4
Capacity (BTU/Hr)*	1940

### ELECTRICAL DATA

Voltage (int'l)	115/60/1 (220/50/1)
Fans	3
Total Amps (int'l)	6.6 (4.4)
10 ft. Cord/Plug [attached] (int'l)	Yes (No)

### SHIPPING DATA

Weight (lbs.)	315 (143 kg)
Height - Crated (in.)	43 1/4 (1099 mm)
Width - Crated (in.)	68 1/4 (1734 mm)
Depth - Crated (in.)	46 (1168 mm)

### DRAWER PAN CONFIGURATIONS

**Two Tier:** (1) 12 x 20 x 6 pan per drawer

**Three Tier:** (1) 12 x 20 x 4 pan per drawer

\* Rating @ +25°F evaporator, 90°F ambient

Figures in parentheses reflect metric equivalents rounded to the nearest whole unit.



Equipped with one NEMA-5-15P Plug  
(varies by country)

# Continental

Refrigerator

Toll-Free: 800-523-7138  
Phone: 215-244-1400  
Fax: 215-244-9579

539 Dunkserry Road  
Bensalem, PA 19020  
[www.continentalrefrigerator.com](http://www.continentalrefrigerator.com)

Due to our continued efforts in developing innovative products, specifications subject to change without notice.



© Copyright 2014. Continental Refrigerator.  
A Division of National Refrigeration & Air Conditioning Products, Inc.

## Model Plan Views

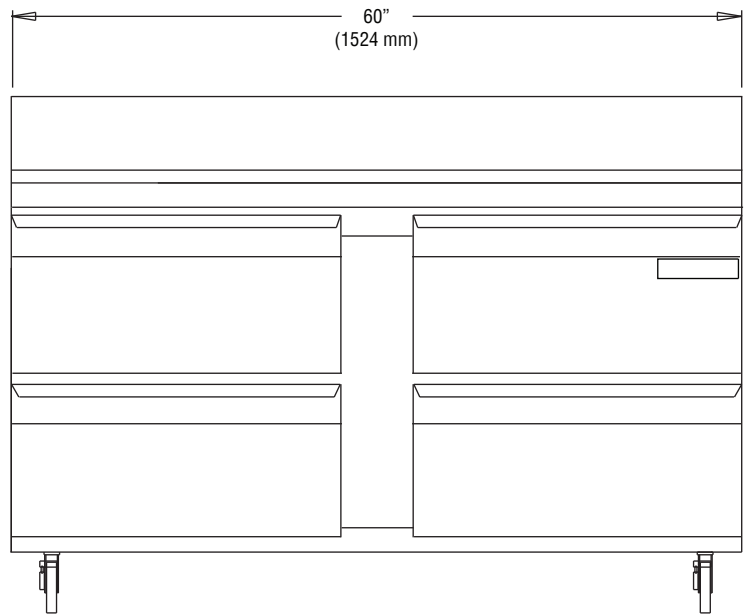

FRONT VIEW

Note: Shown with two tier drawers.

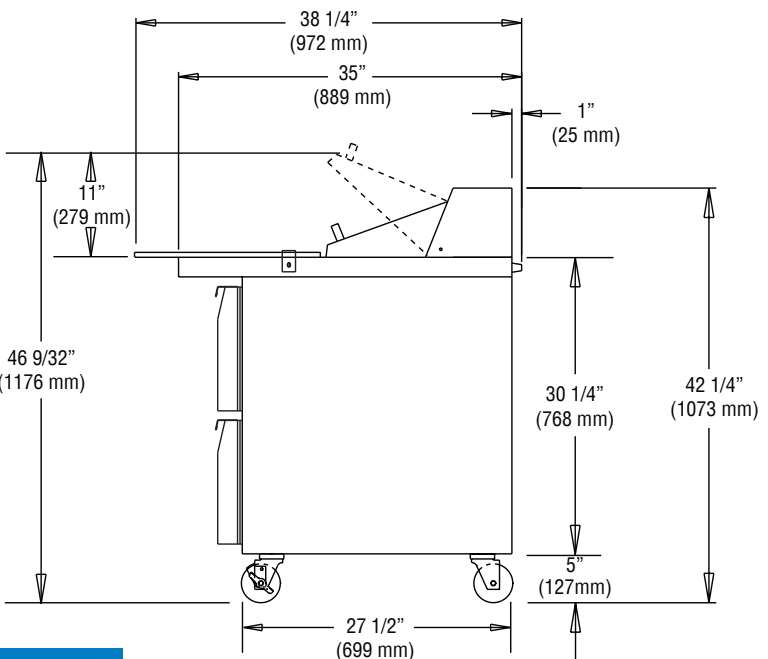

SIDE VIEW

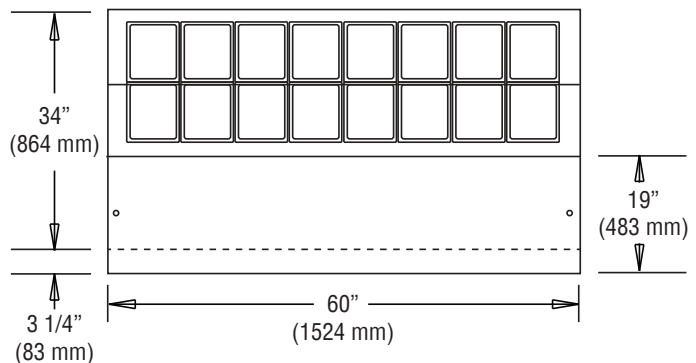

PAN TOP CONFIGURATION