

**PROJECT NAME:** \_\_\_\_\_

**LOCATION:** \_\_\_\_\_

**SPECIFIER ITEM NO.** \_\_\_\_\_ **QTY:** \_\_\_\_\_

**ENCORE PART NO.** \_\_\_\_\_

Encore<sup>®</sup> Deck Mount Utility Spray Assembly

**KL56-2x00-xx**

- KL56-2000      Compression valves, no vacuum breaker
- KL56-2100      Ceramic Valves, no vacuum breaker
- KL56-2000-VB      Compression valves with vacuum breaker
- KL56-2100-VB      Ceramic valves with vacuum breaker

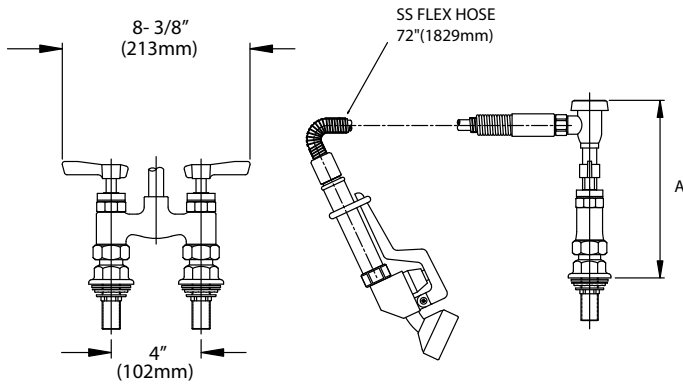

Dimensions shown in inches (mm) are for reference only and are subject to change.

1-1/8" (29mm) holes for deck are recommended to accommodate 1/2" supply nipples.  
1/2" NPS inlets and 1/4" NPT compression fitting inlets  
Operating Temperature: 40-180°F (5-83°C)  
Operating Pressure: 15-125psi

Approximate shipping weight - 10 lbs  
Warranty - 2 years parts

Solid heavy duty cast body is specification and commercial quality

**Commercial Quality Features**

- 1.2gpm spray face
- ADA-compliant lever handles
- 60" flexible S/S hose with Kool Grip™ handle

**SANIGUARD<sup>®</sup> Product Protection**

- Permanently incorporated on all touch points of Encore plumbing fixtures
- Inorganic, silver ion technology inhibits growth of common bacteria, yeasts, mold and fungi, minimizes cross-contamination

**SPECIFICATIONS:**

Deck Mount Utility Spray to be Encore KL56-2000 Series in the following configuration:

- \_\_\_\_\_ KL56-2000      Compression Valves Without Vacuum Breaker
- \_\_\_\_\_ KL56-2100      Ceramic Valves Without Vacuum Breaker
- \_\_\_\_\_ KL56-2000-VB      Compression Valves With Vacuum Breaker
- \_\_\_\_\_ KL56-2100-VB      Ceramic Valves With Vacuum Breaker

Faucet body to be constructed of polished chrome plated brass with total lead content less than 0.25% by weighted average. Lever handles and grip to be incorporated with SANIGUARD treatment. Valves to be 1/4-turn with integral check valve to prevent cross-flow and back-flow. Hose to be 60" flexible stainless steel with Kool Grip™ handle and vacuum breaker. Hose to have Santoprene<sup>®</sup> reinforced inner hose. Hold open ring and hose wall hook to be included.

Model No.	A
KL56-2000	7-3/16" (183mm)
KL56-2100	7-3/16" (183mm)
KL56-2000-VB	8-3/8" (213mm)
KL56-2100-VB	8-3/8" (213mm)

**COMPLIES WITH:**  
ASME A112.18.1-2005  
CSA B125.1-05  
NSF/ANSI 61/9, ANNEX G  
SECTION 116875 OF THE  
CALIFORNIA HEALTH & SAFETY CODE  
(COMMONLY KNOWN AS AB1953)  
VERMONT ACT 193  
UNIFORM PLUMBING CODE

