



Profit from the Eagle Advantage®

Specification Sheet

Short Form Specifications

Eagle Spec-Bar® Wall Mounted Sink model WS14-15. Heavy gauge type 304 stainless steel sink and body. T&S deck mounted faucet, 1½" stainless steel I.P.S. threaded drain with nut and washer, and stainless steel wall mounting brackets.

Eagle Spec-Bar® Wall Mounted Sink model WSD14-15. Heavy gauge type 304 stainless steel sink and body. Front panel door towel dispenser, deck mount soap dispenser, T&S deck mounted faucet, 1½" stainless steel I.P.S. threaded drain with nut and washer, and stainless steel wall mounting brackets.

Eagle Spec-Bar® Wall Mounted Sink model WSS14-15. Heavy gauge type 304 stainless steel sink and body. Perforated sink strainer, T&S deck mounted faucet, 1½" stainless steel I.P.S. threaded drain with nut and washer, and stainless steel wall mounting brackets.

Eagle Spec-Bar® Wall Mounted Sink model WSSDI12-15. Heavy gauge type 304 stainless steel sink, drop-in type with T&S deck mounted faucet and 1½" stainless steel I.P.S. threaded drain with nut and washer.



#WS14-15 sink

Item No.:	_____
Project No.:	_____
S.I.S. No.:	_____

Spec-Bar® Wall Mounted Sinks

MODELS:

- WS14-15
- WSD14-15
- WSS14-15
- WSSDI12-15

Design and Construction Features

- Constructed of type 304 stainless steel for strength and corrosion resistance.
- Back, backsplash, sides, bottom, front panel or front door, trim rail, and bowls are constructed of 20 gauge stainless steel.
- Wall mounting brackets and top (on drop-in model) are 18 gauge stainless steel.
- Sink bowl is 9¼" x 11½" x 6" deep (235 x 292 x 152mm), with hot and cold water T&S gooseneck faucet.
- T&S faucets are deck mounted on 4" (102mm) centers, with ½" (13mm) NPT inlets and hot and cold water connections required.
- Available as a handsink, wet waste sink, or deluxe hand sink with soap and c-fold paper towel dispenser. Also available as a drop-in sink.
- #WSS14-15 includes perforated sink strainer.
- 1½"(38mm) I.P.S. threaded drain with nut and washer.

EAGLE GROUP
 100 Industrial Boulevard, Clayton, DE 19938-8903 USA
 Phone: 302-653-3000 • Fax: 302-653-2065
 www.eaglegrp.com

Foodservice Division: Phone 800-441-8440
MHC/Retail Display Divisions: Phone 800-637-5100

For custom configuration or fabrication needs, contact our **SpecFAB® Division**.
 Phone: 302-653-3000 • Fax: 302-653-3091 • e-mail: specfab@eaglegrp.com



EG40.35 Rev. 04/11

Spec sheets available for viewing, printing or downloading from our online literature library at www.eaglegrp.com



Profit from the Eagle Advantage®

Item No.: _____
 Project No.: _____
 S.I.S. No.: _____

Spec-Bar® Wall Mounted Sinks

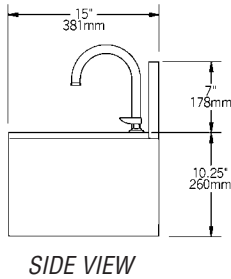
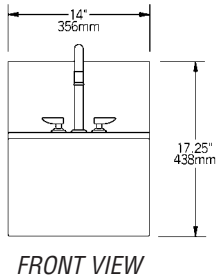
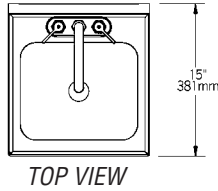

model #	description	width in. mm	length in. mm	weight lbs. kg
WS14-15	with front panel	15" 381	14" 356	22 10.0

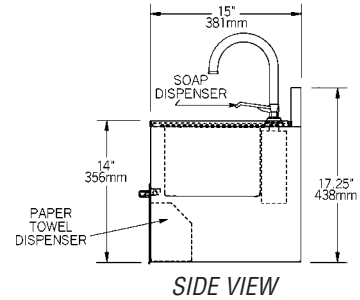
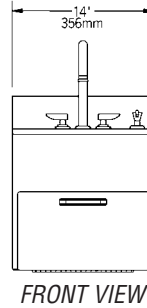
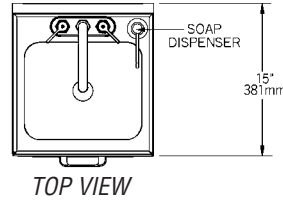

model #	description	width in. mm	length in. mm	weight lbs. kg
WSD14-15	w/front door and dispensers	15" 381	14" 356	30 13.6

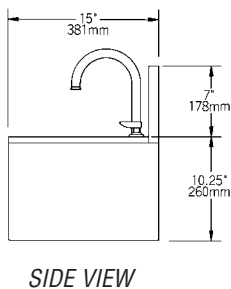
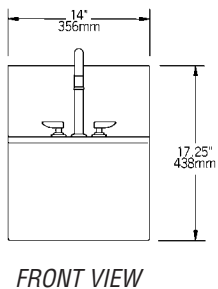
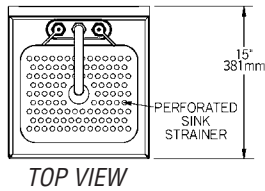

model #	description	width in. mm	length in. mm	weight lbs. kg
WSS14-15	w/perforated sink strainer	15" 381	14" 356	25 11.3

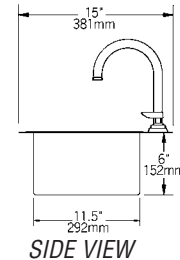
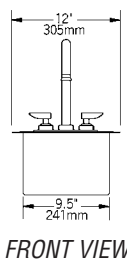
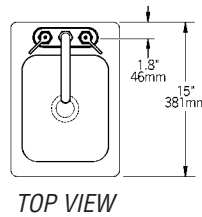

model #	description	width in. mm	length in. mm	weight lbs. kg
WSSD12-15	drop-in model	15" 381	12" 305	15 6.8

EAGLE GROUP
 100 Industrial Boulevard, Clayton, DE 19938-8903 USA
 Phone: 302-653-3000 • Fax: 302-653-2065
 www.eaglegrp.com

Foodservice Division: Phone 800-441-8440
 MHC/Retail Display Divisions: Phone 800-637-5100

Printed in U.S.A.
 ©2011 by Eagle Group

Rev. 04/11

Spec sheets available for viewing, printing or downloading from our online literature library at www.eaglegrp.com

Although every attempt has been made to ensure the accuracy of the information provided, we cannot be held responsible for typographical or printing errors. Information and specifications are subject to change without notice. Please confirm at time of order.