

Item No.:	_____	Qty.:	_____
Model No.:	_____		
Project No.:	_____		



Standard Series Mop Sink

Standard Series Mop Sink

- FLR-1X**
- FLR-2X**
- FLR-3X**
- FLR-4X**

Features

- 16 Gauge, 300 series stainless steel
- Stainless steel skirt
- Welded construction for consistent metal gauge thickness throughout
- 3-1/2" (88.9 mm) drain with flat strainer included

Options

- Back / Side Splashes
- Faucet Options

Materials

- Top: Tub is 16 gauge, 300 series stainless steel
- Skirt: 18 gauge stainless steel

Flyer Product



AUTOQUOTES



In keeping with our policy of continuing product improvement, Elkay SSP reserves the right to change product specifications without notice.

This specification describes an Elkay SSP product with design, quality and functional benefits to the user. When making a comparison of other producers' offerings, be certain these features are not overlooked.

Elkay SSP
421 N. Freya St.
Spokane, WA 99205
Phone: 800-726-0553 Fax: 509-535-1493

Website: www.sspinc.net
Email: sspsales@elkay.com
©2011 Elkay



Item No.: _____ Qty.: _____

Model No.: _____

Project No.: _____

Standard Series Mop Sink

Standard Series Mop Sink

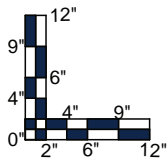
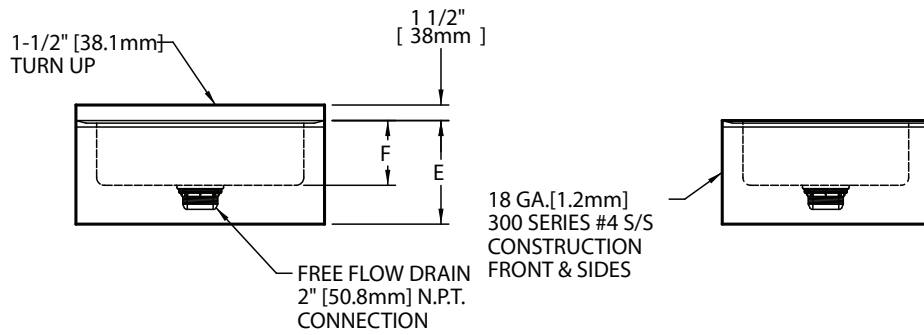
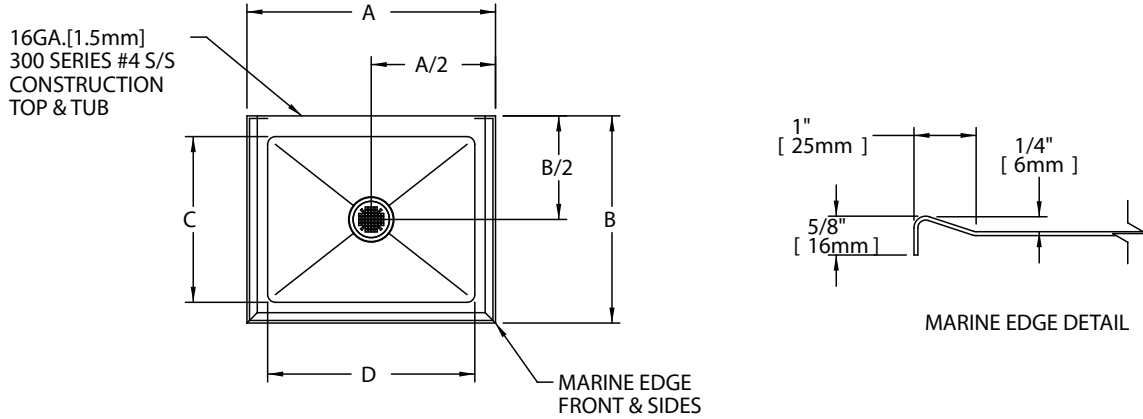

Floor Mop Sinks																
	Bowl Dimensions						Overall Size						Drain Location		Weight	
	Width		Front-to-Back		Depth		Width		Front-to-Back		Height		DL			
	D	C	F	A	B	E	in.	mm	in.	mm	in.	mm	in.	mm	lbs.	kg
FLR - 1 X	20	16	6	24	20	10	24	508	20	610	10	191	12.0	305	61	28
FLR - 2 X	28	20	6	32	24	10	32	610	24	813	10	191	16.0	406	76	35
FLR - 3 X	20	16	12	24	20	16	24	508	20	610	16	343	12.0	305	72	33
FLR - 4 X	28	20	12	32	24	16	32	610	24	813	16	343	16.0	406	90	41

