



EV9795-80

E-10 Prefilter System

Prefilter System for foodservice applications



E-10 Prefilter System: EV9795-80

EC110 Prefilter Cartridge: EV9534-12

BENEFITS

- Filters out larger dirt and rust particles
- Extends the life of primary filter cartridges
- Tightly spun EC110 sediment cartridge delivers 10 micron nominal filtration
- Durable slim bowl design makes cartridge change outs easy to handle
- Clear housing lets you visually inspect trapped particles and makes determining when to change the cartridge easy
- 10" bowl design accepts most 10" drop in cartridges

INSTALLATION TIPS

- Choose a mounting location suitable to support the full weight of the system when operating
- Make sure to properly lubricate O-ring prior to use
- Use 3/4" water line (Optional reducer bushings included)
- Install vertically with bowl hanging down
- Allow 2-1/2" clearance below the cartridge for easy cartridge replacement

OPERATION TIPS

- Inspect EC110 cartridge periodically to determine dirt load
- Replace EC110 cartridge when dirt has penetrated through to the inner core of the cartridge
- Do not exceed service flow rate
- Inspect O-ring during each cartridge change. Lubricate and/or replace if necessary

APPLICATION/SIZING

- For all foodservice applications requiring prefiltration
- High sediment areas

E-10 Prefilter System

SPECIFICATIONS

Overall Dimensions:
12.44"H x 5.16"W x 5.5"D

Inlet connection: 3/4"

Outlet connection: 3/4"

Service Flow Rate:
Maximum 6.0 gpm (22.7 Lpm)

Pressure Requirements:
10 - 125 psi (0.7 - 8.6 bar), non-shock

Temperature: 35 - 100°F (2 - 38°C)

No electrical connection required

Shipping Weight: 4 lbs.

Operating Weight: 6 lbs.

The contaminants or other substances removed or reduced by this drinking water system are not necessarily in your water. Do not use with water that is microbiologically unsafe or of unknown quality without adequate disinfection before or after the system. Systems certified for cyst reduction may be used with disinfected water that may contain filterable cysts.

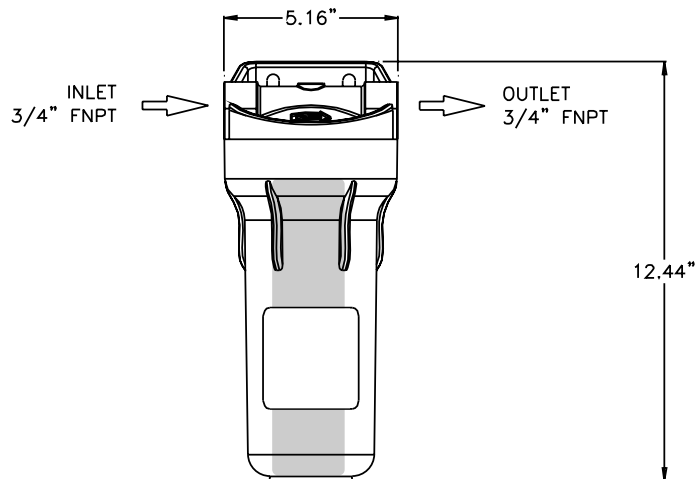

WARRANTY

Everpure water treatment systems (excluding replaceable elements) are covered by a limited warranty against defects in material and workmanship for a period of five years after date of purchase. Everpure replaceable elements (filter cartridges and water treatment cartridges) are covered by a limited warranty against defects in material and workmanship for a period of one year after date of purchase. See printed warranty for details. Everpure will provide a copy of the warranty upon request.

EVERPURE®

EVERPURE, INC.
2375 Sanders Road
Northbrook, IL 60062
Toll Free (800) 323-7873
Tel (847) 205-6000
Fax (800) 942-0081
<http://www.everpure.com>

In Europe:
N.V. EVERPURE (EUROPE) S.A.
Geldenaaksebaan 478
B-3001 Heverlee
Belgium
Tel 32-16-401191
FAX 32-16-402691

In Japan:
EVERPURE JAPAN, INC.
1-8-19, Tsumada Kita,
1-Chome, Atsugi City
Kanagawa Ken 243-0812
Japan
Tel 81-462-23-6563
FAX 81-462-21-6775

Everpure, Inc.
2375 Sanders Road
Northbrook, IL 60062
Phone: 800-323-7873 Fax: 800-942-0081