

24" GLASS DOOR BACK BAR COOLERS



EVEREST
REFRIGERATION
www.EVERESTref.com

EBB – Series

- EBB48G-24 • EBB59G-24
- EBB69G-24 • EBB90G-24



EBB48G-24



EBB59G-24



EBB69G-24



EBB90G-24

Cabinet Construction

Heavy duty stainless steel countertop, with textured and laminated black vinyl exterior. Galvanized steel interior wall, and high quality stainless steel floor. 1 3/4" thick high density foamed-in-place polyurethane insulation. Built-in caster thread receptacles for all units.

Refrigeration System

- Side mounted condensing unit
- Oversized condenser and evaporator coils quickly achieve and maintain desired temperature
- Forced-air cooling with oversized evaporator fan motors providing balanced airflow throughout cabinet to ensure faster temperature drop
- Removable side panel and slide-out condensing unit for convenient repair and maintenance
- Environmentally friendly CFC free R-134A refrigerant
- Air defrost controlled by electrical timer
- Copper tube and aluminum fin evaporator with anti-corrosive coating
- Energy efficient condensate drain pan assembly heated by high side copper tube
- Pre-wired and ready to plug, 115V/60Hz/1Ph, NEMA 5-15P

Doors

- Black PVC door frames
- Low emissivity double pane glass system reflects UV rays and improves insulation for maximized energy efficiency
- One piece snap-in magnetic door gaskets for easy replacement
- Heavy duty die cast door handles
- Door locks

Lighting

- Shielded vertical LED interior lighting with on/off switch for energy saving, less heat generation and enhanced illumination (available from 2015 models)

Shelving

- Two epoxy coated wire shelves per section
- Stainless steel pilasters and shelf clips

Temperature Control

- Factory preset temperature, 35°F
- Temperature setting range from 32°F to 42°F
- Easy to set analog thermostat

Options

- 2 1/2" and 4" diameter casters (3 1/2" and 5" overall height)

- Project / Customer _____
- Item No. _____
- Model No. _____

Warranty
5 Year — Compressor Warranty
3 Year — Parts & Labor Warranty
 Applicable to units purchased after July 1, 2014.

Contact
 201 W. Artesia Blvd, Compton, CA 90220
 T. (310) 323-6586, (800) 444-6285
 F. (310) 323-7524

24" GLASS DOOR BACK BAR COOLERS



EBB – Series

- EBB48G-24 • EBB59G-24
- EBB69G-24 • EBB90G-24

Dimensions

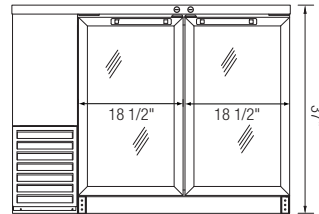
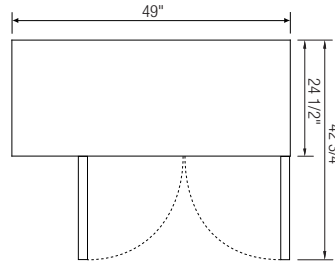
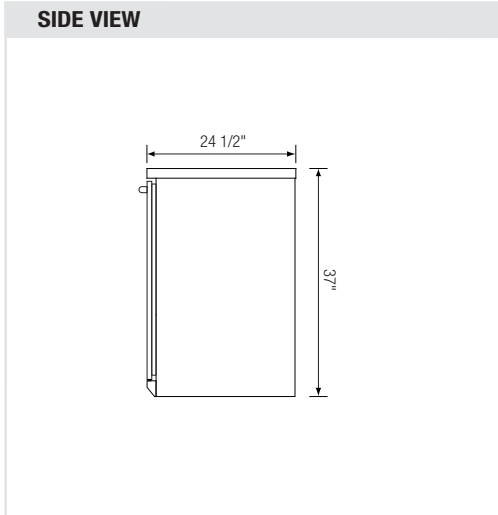

▲ EBB48G-24

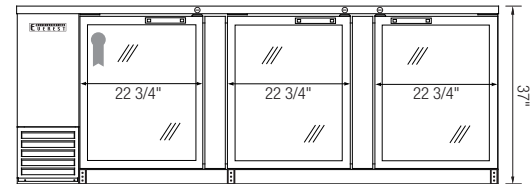
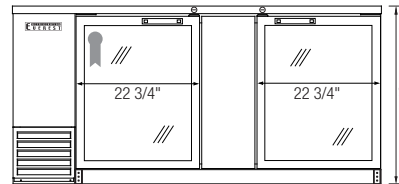
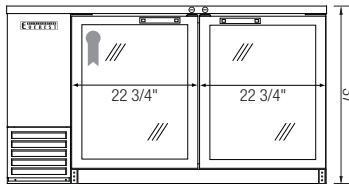
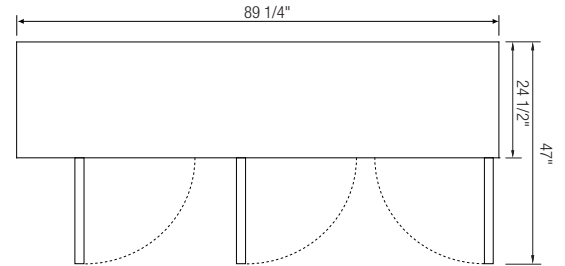
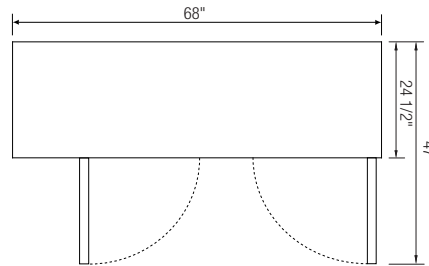
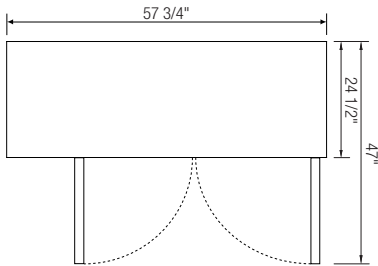

▲ EBB59G-24

▲ EBB69G-24

▲ EBB90G-24

Model	Ref/ Fzr/ Dual	# of Doors	Capacity (Cu.Ft.)	HP	Refrigerant	# of Shelves	Capacity		Power (V-Hz-Ph)	Amps	Crated Weight (LBS)	Exterior Dimensions (Inches)			* Depth does not include protruding door handles Ref = Refrigerator Fzr = Freezer Dual = Ref & Fzr Combo
							12 oz. Cans	12 oz. Bottles				L	D*	H	
EBB48G-24	Ref	2	13.95	1/4	R-134A	4	420	294	115-60-1	4.20	254	49	24 1/2	37	
EBB59G-24	Ref	2	16.86	1/4	R-134A	4	560	357	115-60-1	4.20	276	57 3/4	24 1/2	37	
EBB69G-24	Ref	2	20.41	1/4	R-134A	4	700	441	115-60-1	4.20	320	68	24 1/2	37	
EBB90G-24	Ref	3	27.76	1/3	R-134A	6	980	609	115-60-1	4.50	388	89 1/4	24 1/2	37	

Disclaimer: Product dimensions are for general purposes and not absolute value. Slight variations may exist. If dimensions are critical, please contact Everest.