

Project: _____	AIA# _____
Item #: _____ Qty: _____	SIS# _____
Model #: _____	

Lighted Liquor Displays

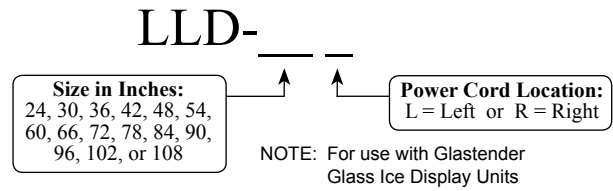
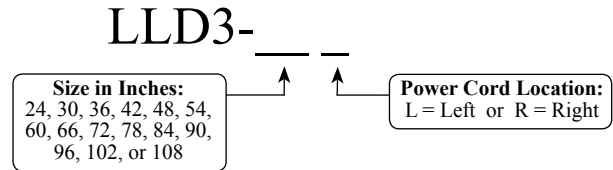
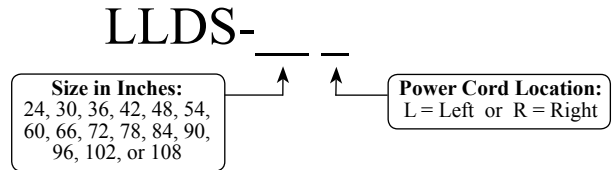

Standard Features

- Durable black-vinyl clad exterior (stainless steel available by special order)
- Power cord and on/off switch can be located left or right to meet your installation requirements.
- One-piece clear acrylic cover is easy to clean and protects internal components from spills. Units are certified to meet ANSI/UL 962 spill test requirements.
- Removable step cover for easy access to fluorescent light bulbs (light bulbs included)
- Access hole provides access to on/off switch
- Available with two (LLDS models) or three (LLD3 models) 4" high by 4" deep steps
- LLD models have two steps and are designed for use in conjunction with Glastender Glass Ice Display Units. The first step is 9-1/4" high and a front light channel helps to illuminate the ice display.

Specifications

- Electrical*
- 115V, 1 phase, 60Hz, less than 5 full load amps
 - Includes on/off switch and 6 foot grounded cord and plug located on the left or right side as specified by the model number
- Materials*
- 22 black vinyl-clad steel: front, back, and sides
 - 22 gauge galvanized steel parts include: interior ballast housing and light bulb platform
 - Top consists of 1/8" thick clear high impact PVC



Intertek
 Conforms to ANSI/UL STD 962
 Certified to CSA STD
 C22.2 No. 12

Glastender, Inc. • 5400 North Michigan Road • Saginaw, MI • 48604-9780 989.752.4275 • 800.748.0423 • Fax 989.752.4444 www.glastender.com	Approval/Notes: _____
Specifications subject to change without notice. For current specifications please visit our website.	

Lighted Liquor Displays

Dimensional Information

Dimensional Details for LLDS Models

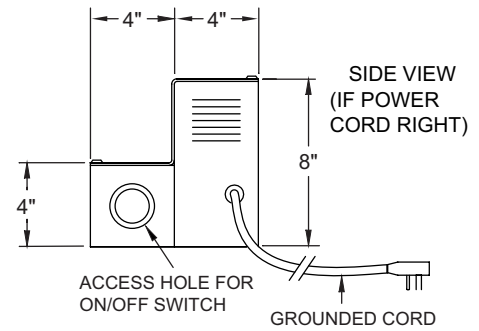
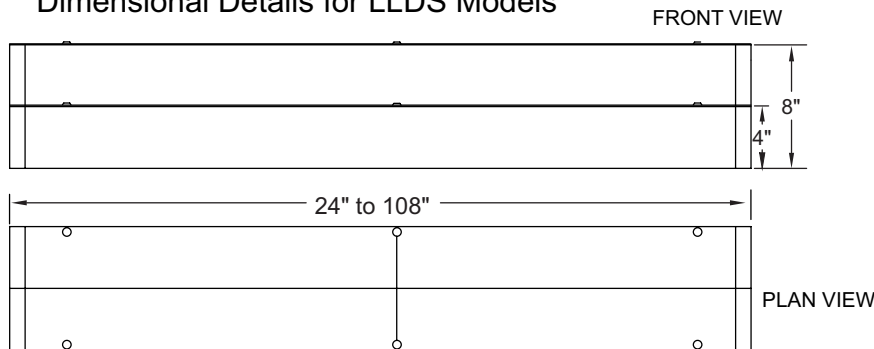

Dimensional Details for LLD3 Models

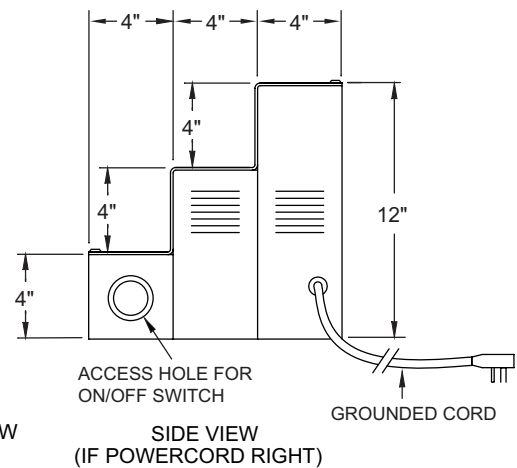
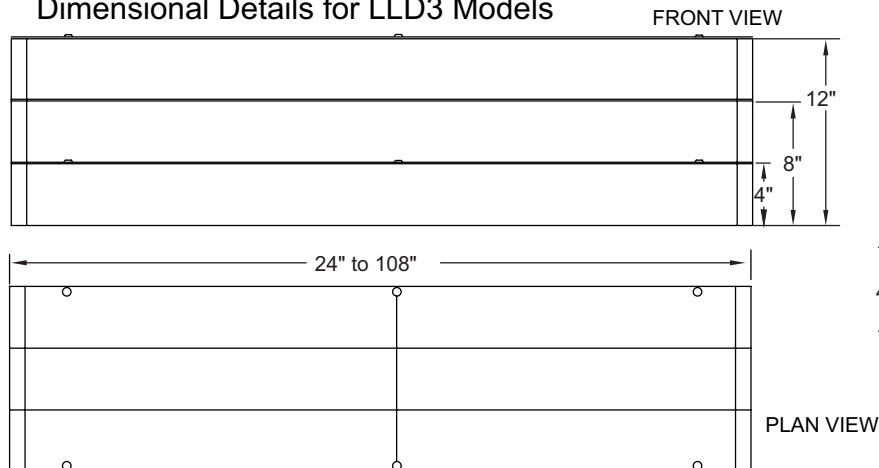

Dimensional Details for LLD Models

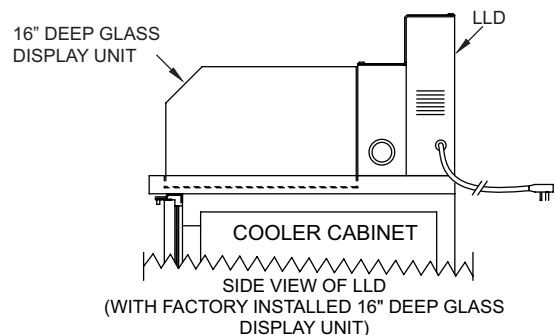
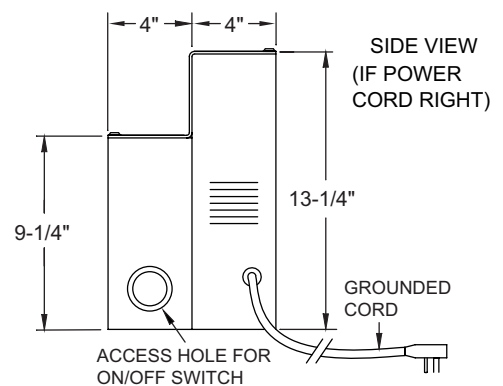
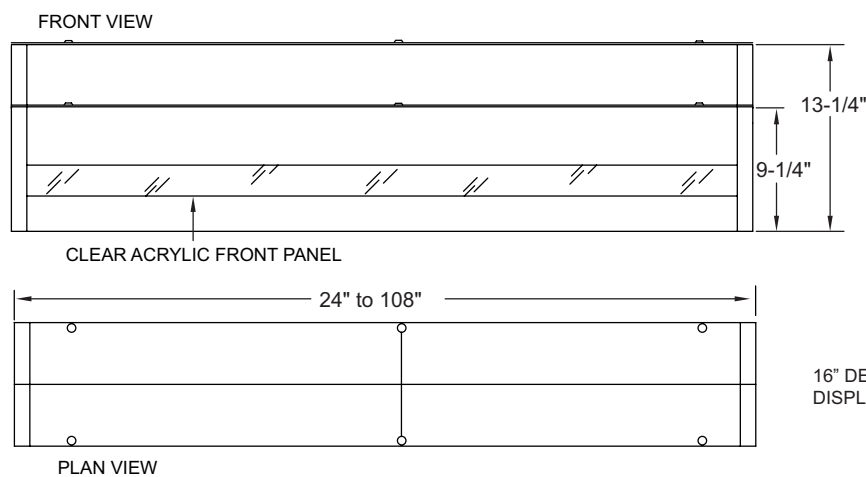

LLD models are designed for use with Glastender Glass Ice Display Units. The 16" Deep GDU models mounted on a cooler at the factory have an 8-1/4" rear deck space specifically designed to fit the 8" deep LLD. The 9-1/4" high first step of the LLD raises the bottles above the back of the GDU and the front light channel helps to illuminate the GDU. (See the side view detail.)



5400 North Michigan Road • Saginaw, MI • 48604-9780
 989.752.4275 • 800.748.0423 • Fax 989.752.4444
 www.glastender.com

Printed in USA