

## Intek Steamer model XS4

### Model Numbers

XS4-208-6-1	(208V, 6kW, 1-Phase)
XS4-208-8-1	(208V, 8kW, 1-Phase)
XS4-208-8-3	(208V, 8kW, 3-Phase)
XS4-208-12-3	(208V, 12kW, 3-Phase)
XS4-208-14-3	(208V, 14kW, 3-Phase)
XS4-240-6-1	(240V, 6kW, 1-Phase)
XS4-240-8-1	(240V, 8kW, 1-Phase)
XS4-240-8-3	(240V, 8kW, 3-Phase)
XS4-240-12-3	(240V, 12kW, 3-Phase)
XS4-240-14-3	(240V, 14kW, 3-Phase)
XS4-480-12-3	(480V, 12kW, 3-Phase)

### Description

The Intek XS4 connectionless countertop steamer unit has a pan capacity of 4 pans (2.5" deep 12" x 20"). Unit must be capable of producing steam at 212°F with no water or drain connection required. Unit is to have inverted convection fan technology and includes a 1 year parts and labor warranty. NSF listed as both steamer and holding cabinet. UL listed.

### Construction

- 14 gauge reinforced stainless steel cavity
- Insulated cavity and double door panel
- Heavy refrigeration style door handle with magnetic latch
- Stainless steel wire racks positioned to support (4) 2.5" deep pans

### Operation

- Inverted flow convection fan in cooking chamber
- NSF approved holding cabinet
- Open door while cooking
- Heating element external to compartment and not exposed to water
- 3 gallon capacity water reservoir

### Options/Accessories

- Stand w/Bullet Feet for Single or Double Stack
- Casters for Stand
- Flanged Feet for Stand
- Door Hinged Left
- Correction Package
- Drain Line
- Trivet

Model XS4



### Origin of Manufacture

Steamer shall be designed and manufactured in the United States.

**4 Pan Capacity  
Stainless Steel  
Pressureless,  
Connectionless Steamer**

**Table Top  
Self-Contained  
Electric Heated**

### Short Form

Groen Intek XS4 4-pan connectionless countertop steamer unit is available as 208, 240 or 480 volt, single or three phase, 6, 8, 12, or 14kW (12 and 14kW available in three phase only) steam cooker with a pan capacity of 4 pans (2.5" deep 12" x 20"). Unit must be capable of producing steam at 212°F with no water or drain connection required. Unit must be a NSF approved holding vessel. 4" stainless steel adjustable legs with flanged feet. Unit is to have inverted convection fan technology and includes a 1 year parts and labor warranty. Unit to be NSF and UL listed and manufactured in the U.S.A.



### Applications

Pasta  
Rice  
Vegetables (Fresh & Frozen)  
Seafood (Fresh & Frozen)  
Poultry  
Potatoes  
Eggs  
Meats  
Reheat Cook-Chill & Prepared Foods

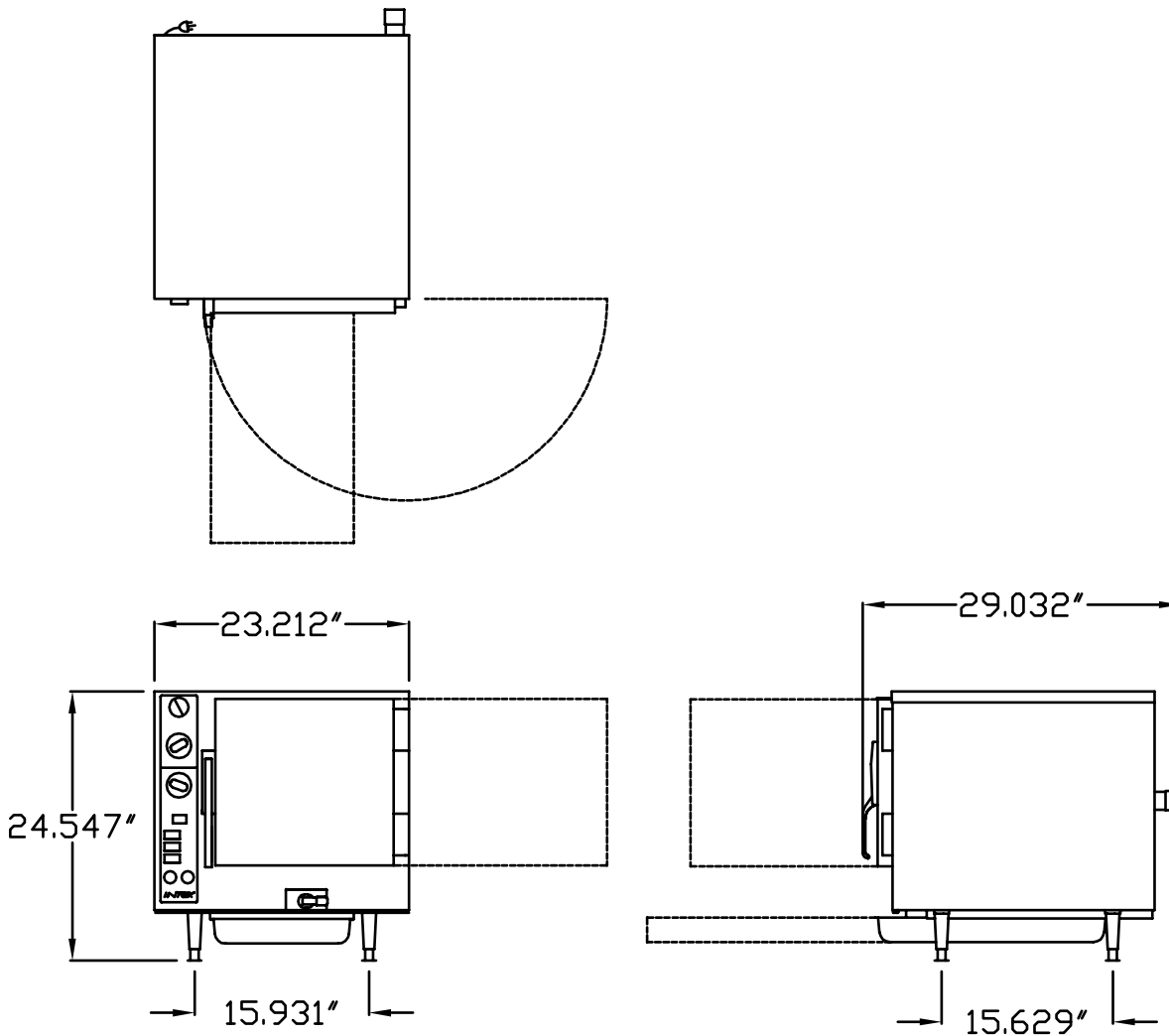

Model No.	No. of Pans	Voltage	KW/hr	NEMA	Width IN	Depth IN	Height* IN	Weight LBS
XS4-208-6-1	4	208/60/1	6	6-50P	23-1/4"	29"	24-1/2"	270
XS4-208-8-1	4	208/60/1	8	6-50P	23-1/4"	29"	24-1/2"	270
XS4-208-8-3	4	208/60/3	8	L15-30P	23-1/4"	29"	24-1/2"	270
XS4-208-12-3	4	208/60/3	12	15-50P	23-1/4"	29"	24-1/2"	270
XS4-208-14-3	4	208/60/3	14	15-50P	23-1/4"	29"	24-1/2"	270
XS4-240-6-1	4	240/60/1	6	6-50P	23-1/4"	29"	24-1/2"	270
XS4-240-8-1	4	240/60/1	8	6-50P	23-1/4"	29"	24-1/2"	270
XS4-240-8-3	4	240/60/3	8	L15-30P	23-1/4"	29"	24-1/2"	270
XS4-240-12-3	4	240/60/3	12	15-50P	23-1/4"	29"	24-1/2"	270
XS4-240-14-3	4	240/60/3	14	15-50P	23-1/4"	29"	24-1/2"	270
XS4-480-12-3	4	480/60/3	12	L16-20	23-1/4"	29"	24-1/2"	270
170944	STAND W/BULLET FEET, FOR SINGLE OR DOUBLE STACKED				27"	32.5"	47"	62

\*Overall height of units installed on a single stand is 54.5".  
Overall height of units installed on a double stand is 67".



**XS4 SINGLE AND  
DOUBLE STACKED  
UNITS**

Stands shown with optional casters.  
Stands standard with bullet feet.

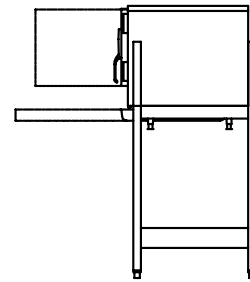
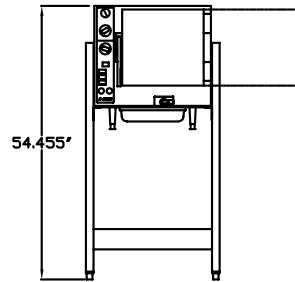
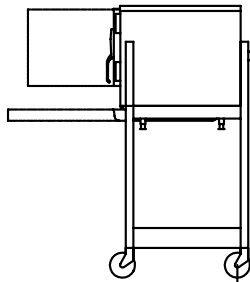
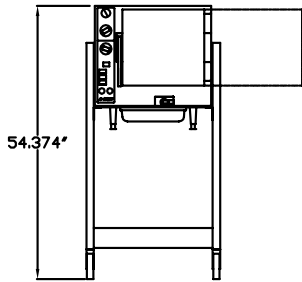
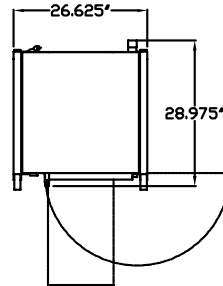
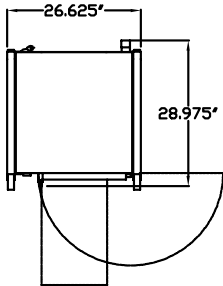

**XS4 ON 10CA**

**XS4 ON 10NC**

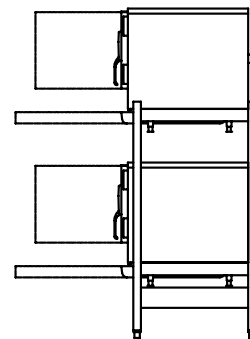
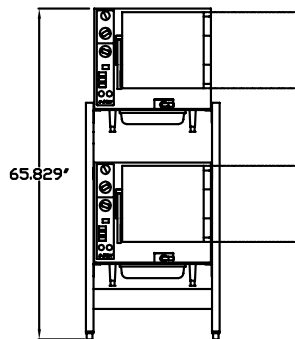
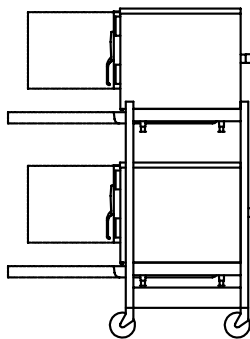
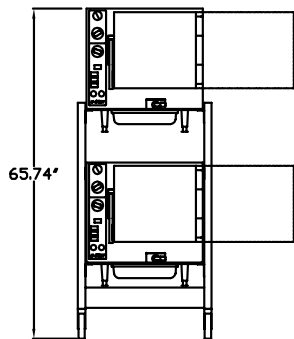

**XS4 ON 20CA**

**XS4 ON 20NC**

