

HOBART701 S Ridge Avenue, Troy, OH 45374
1-888-4HOBART • www.hobartcorp.com**FD3/50 FD3/75 FD3/125
FOODWASTE DISPOSERS****HOBART****COMPACT SIZE -
BIG VERSATILITY**

Hobart Disposers are well recognized for quality and capacity. They're designed with your needs in mind - built with a large capacity for food wastes.

The following pages illustrate the variations of controls and accessories available to make these food waste disposers the most versatile equipment for small to medium sized clean-up systems.

SPECIFICATIONS

Listed by Underwriters Laboratories Inc. and meets requirements of A.S.S.E. Standard No. 1009 (50 Hz. Electrical Specifications not UL Listed.)

MOTORS: Continuous duty rating, equipped with manual reset thermal overload inherent protector. Permanently lubricated ball bearings for upper and lower shelf support. Upper bearing is sealed on both sides.

HOUSINGS: Heavy aluminum grind and discharge housings. Four bolts fasten the motor unit to the grind chamber, permit easy removal.

MOUNTING: All Hobart Disposers (except when using accessory group E), fasten to 7" I.D. (throat opening) cones. A vinyl isolating ring eliminates metal-to-metal contact at the cone mounting, reduces vibration and noise transmission.

STATIONARY SHREDDER RING: 1 $\frac{3}{4}$ " high, 4 machine ground primary action breaker bars, 42 secondary action grinding teeth.

FLYWHEEL: Breaker blade, mounted at center, speeds grinding, prevents objects from "riding" at center. Two hardened stainless steel cutter blocks (fastened to flywheel with nylock screws) are replaceable, can be indexed for new cutting edges. Ni-Resist flywheel is 6 $\frac{3}{16}$ " diameter, slots undercut the shredder ring to assure that particles are cut to proper size before passing to the drain line.

MOTOR SHAFT SEAL: Face-type seal consists of sintered bronze mating ring and spring loaded carbon ring insert in chemical resistant neoprene bellows. Mating surfaces are protected from grit or fibers by being recessed into flywheel. Should any moisture pass this seal, a flinger and drain tube are provided to insure immediate removal. In addition, a lip-type oil seal (located beneath the bearings) is an "added protection" water seal.

DRAIN CONNECTOR: A chrome plated brass tail-piece is provided for connection to a 1 $\frac{1}{2}$ " standard drain trap.

DUAL DIRECTIONAL GRINDING: All Disposers operate in either direction of flywheel rotation. Direction of rotation can be controlled by the operator (to increase life and efficiency of grinding elements — back flywheel free of a "jam") when installed with Control Groups 5 & 6.

WEIGHT: Shipping – Approx. 60 lbs. (does not include accessory group or controls).



Long Housing Model

FD3-50 FD3-75 FD3-125 FOODWASTE DISPOSERS

FD3/50 FD3/75 FD3/125 FOODWASTE DISPOSERS



701 S Ridge Avenue, Troy, OH 45374
1-888-4HOBART • www.hobartcorp.com

ACCESSORY GROUPS



GROUP A (For use with long upper housing only.)

-  Vinyl Scrapping Ring
-  Stainless Steel Silver-Saver Sleeve with Side Feed Hole
-  Water Swirl
-  Vacuum Breaker

GROUP B (For use with long upper housing only.)

-  Vinyl Silver-Saver Splash Guard Ring
-  Water Swirl
-  Vacuum Breaker

GROUP C (For use with long upper housing only.)



-  Vinyl Silver-Saver Splash Guard Ring
-  Vacuum Breaker
-  Pre-Rinse Spray with Wall Bracket

GROUP E (For use with short upper housing only.)

- NOTE: For use with short Upper Housing Foodwaste Disposer only.
-  Cover Stopper and Sink Adapter Assembly for 3 1/2" to 4" Sink Opening
 -  Fixed Direction Water Inlet for Sink
 -  Vacuum Breaker

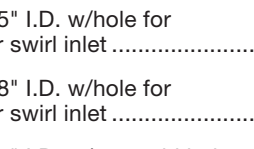
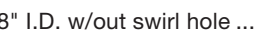

ACCESSORY COMPONENTS

CONES-SINK—Stainless Steel

-  Cone 15" I.D. w/hole for water swirl inlet 204007
-  Cone 18" I.D. w/hole for water swirl inlet 204004
-  Cone 15" I.D. w/out swirl hole 204006
-  Cone 18" I.D. w/out swirl hole 204003

-  Sink 16" x 20" x 7" (7" opening) w/hole for water inlet.....204015-2

WATER INLETS

-  Cone Water Swirl Inlet 1/2" N.P.T..... 204380
-  Fixed Direction Water Inlet (for sinks or troughs) 1/2" N.P.T..... 204346

FLOW CONTROL

-  Part No.
5 Gallons per minute for Model FD3/50 through FD3/125 — 3/4" N.P.T..... 201721

CONE COVER – STAINLESS STEEL

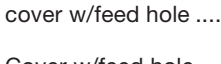
-  15" Cone cover w/feed hole 204024
-  18" Cone Cover w/feed hole..... 204023

CONE FEEDING ACCESSORIES

-  Vinyl Scrapping Ring..... 202113
-  Stainless Steel Silver-Saver Sleeve with side feed hole..... 203870

SILVER-SAVER SPLASH GUARD RING

-  Vinyl Silver-Saver and Splash Guard Ring (for 7" opening cones, sinks and adapter) 202120

VACUUM BREAKERS – Chrome Plated

-  3/4" 277112

PRE-RINSE SPRAYS

-  PR-3 Heavy-duty Flexible Pre-Rinse Spray (38" high with wall bracket) ML-32333

Adapters are available to install Hobart Disposers on existing cones. See Form F7543.



701 S Ridge Avenue, Troy, OH 45374
1-888-4HOBART • www.hobartcorp.com

FD3/50 FD3/75 FD3/125 FOODWASTE DISPOSERS

ELECTRICAL CONTROL GROUPS Listed by Underwriters Laboratories Inc., for use with FD3 Disposers (50 Hz. Electrical Specifications not submitted for UL Listing.)

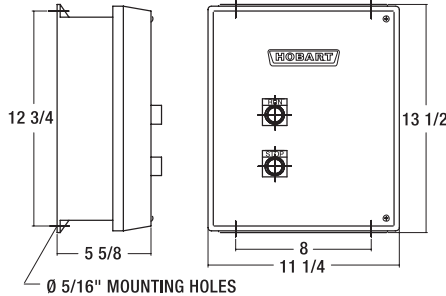

Group 5 - For all Models
Includes:
Magnetic Contactors
Pushbutton Start and Stop
Automatic Reversing
Made from a NEMA 4 Enclosure
Solenoid Valve (24 V only)

Approximate
Shipping Wt. 19 lbs.

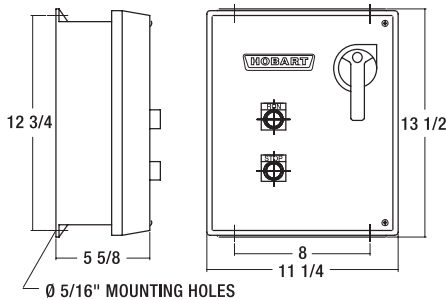

Group 6 - For all Models
Includes:
Magnetic Contactors
Pushbutton Start and Stop
Automatic Reversing
Time Delay for water after shut-off
Line Disconnect
Solenoid Valve (24 V only)
Made from a NEMA 4 Enclosure

Approximate
Shipping Wt. 20 lbs.

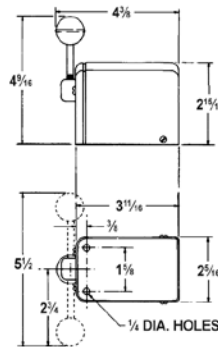

Group 4 - For Models thru FD3/200
Includes:
Manual Reversing Switch
NEMA 1 Enclosure Standard
NEMA 4 Enclosure Optional
Not available above 250 volts
Optional Solenoid Valve

Approximate
Shipping Wt. 11 lbs.

Model	H.P.	Ph.	Hz.	Volts	Rated Amps
FD3/50	1/2	1	60	120/208-240	9.2/4.2-4.6
		3	60	208-240/480	1.8-2.0/1.0
FD3/75	3/4	1	60	120/208-240	10.8/5.3-5.4
		3	60	208-240/480	2.6-3.0/1.5
FD3/125	1 1/4	1	60	120/208-240	14.8/7.7-7.4
		3	60	208-240/480	4.2-4.0/2.0
FD3/50	1/2	1	50	110-120/220-240	Contact Customer Service For Amperage Data
		3	50	220-240/380-415	
FD3/75	3/4	1	50	110-120/220-240	
		3	50	220-240/380-415	
FD3/125	1 1/4	1	50	110-120/220-240	
		3	50	220-240/380-415	

The dash (-) between voltages represents the range (low-high) of voltage operation. The slant (/) line indicates the dual voltage operation accomplished by motor lead connection: follow connecting diagram on motor. (50 Hz. models not submitted for UL Listing.)

SAMPLE SPECIFICATION

FD3/75 – B – 4 (230/60/3)

Electrical Specifications

Electrical Control Group

Accessory Group

Model Number

Cut hole 19" for 18" cone. Hole to be 16" for 15" cone.

Solenoid must be installed in upright position.

Disposer may be easily rotated for better drain line connection.

Center line at wall outlet of trap should not be higher than center line of disposer discharge opening.

If water pressure is in excess of 60 P.S.I. install a pressure reducing valve.

FD3/50 FD3/75 FD3/125 FOODWASTE DISPOSERS



701 S Ridge Avenue, Troy, OH 45374
1-888-4HOBART • www.hobartcorp.com

DETAILS AND DIMENSIONS

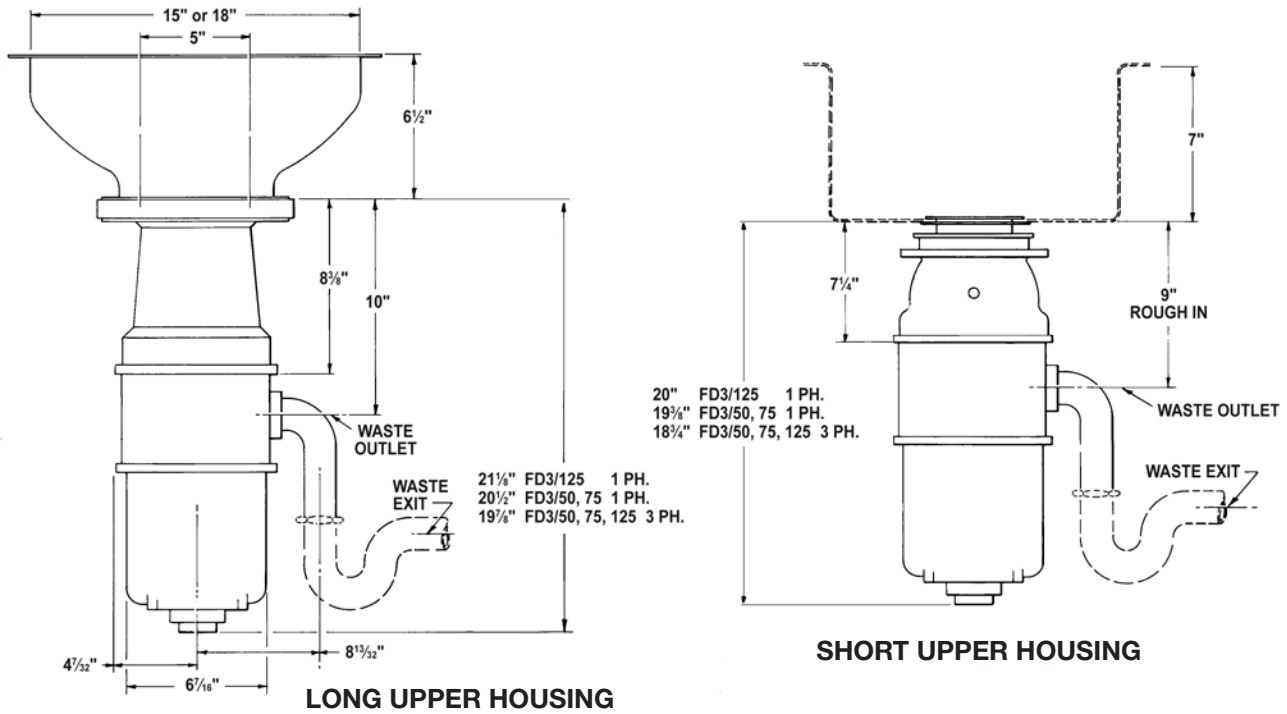

TYPICAL INSTALLATION - Unit with Long Upper Housing.

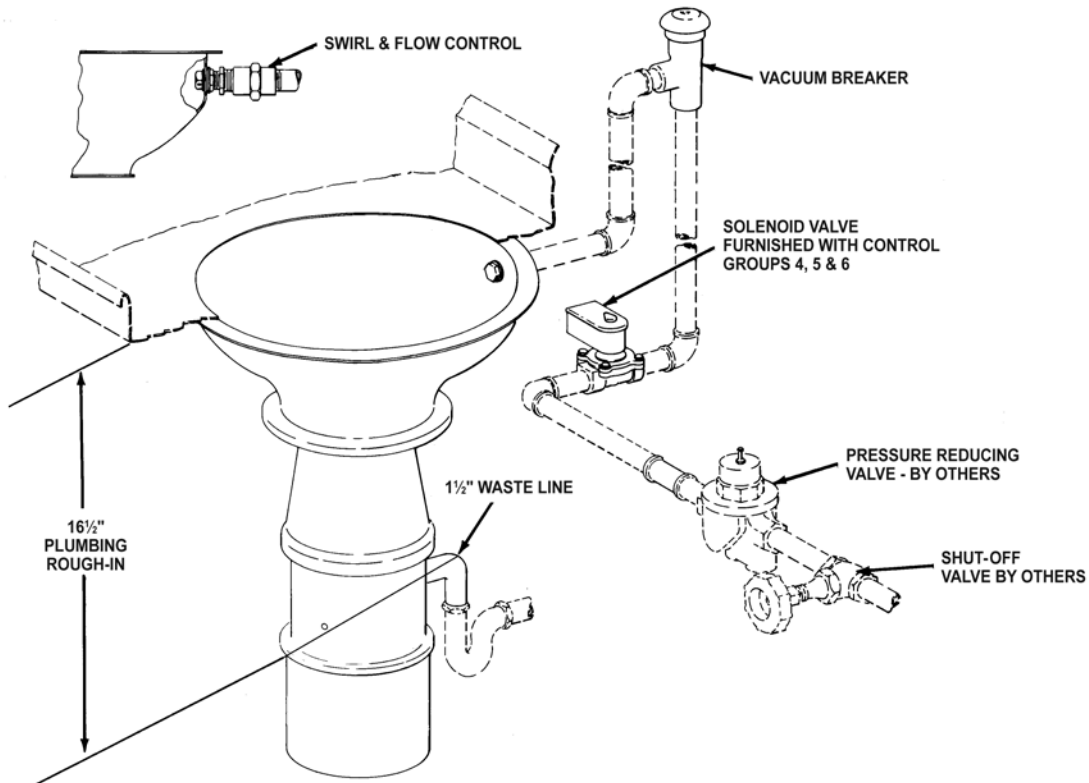

As continued product improvement is a policy of Hobart, specifications are subject to change without notice.