



# FOOD MACHINE ATTACHMENTS AND ACCESSORIES

## 9" VEGETABLE SLICER

Listed by National Sanitation Foundation

One of the most useful Hobart Attachments is the Vegetable Slicer.

It will more than double the utility of a Hobart Mixer or Food Cutter. Its uses are many and varied: cutting cabbage for salads and cole slaw, slicing potatoes ranging in thickness from that of a potato chip to  $\frac{5}{8}$ ". Slicing nuts, bananas, cucumbers, celery and other vegetables and fruits, shredding or grating cheese, raw carrots, beets, etc.

The food is sliced by stainless steel scimitar knives for fast clean, uniform cutting. The front of the Vegetable Slicer is hinged at one side, and can be swung aside or removed, permitting quick and easy changing of plates and cleaning.

The Vegetable Slicer Attachment includes back case, hopper front and adjustable slice plate. Shredder and grater plates (interchangeable with slice plate) and Tubular front are available at extra cost.

The 9" Vegetable Slicer may also be used with the PD-35 or PD-70 Power Drive units or with the Speed Drive Attachment for higher volume output.

### SPEED DRIVE ATTACHMENT

Listed by National Sanitation Foundation

Attaches easily to the No. 12 or No. 22 (with adapter) drive hub of Hobart Mixers, Food Cutters and Grinders. Will increase the speed of the Hobart 9" Vegetable Slicer by more than three times. For high speed slicing, shredding and grating. Not suited for increasing the speed of the Dicer Attachment or the Power Drive Unit and will not accept meat chopping ends.

9" VEGETABLE SLICER

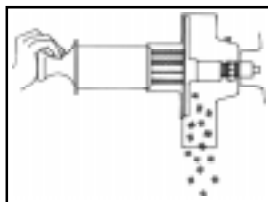

Tubular front is available for cutting at right angles to direction of plate.

SHREDDER AND GRATER PLATES FOR 9" VEGETABLE SLICER



Adjustable Slice Plate -  $\frac{5}{8}$ " to very thin.

Plate Holder Assembly

Grater Plate

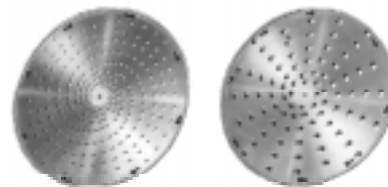

$\frac{3}{32}$ " Shredder Plate

$\frac{5}{16}$ " Shredder Plate

( $\frac{3}{16}$ " and  $\frac{1}{2}$ " plates not shown)



## DICER ATTACHMENT:

Listed by National Sanitation Foundation

The Dicer Attachment adds versatility to Hobart Mixers and Food Cutters and assures efficient performance for dicing needs—from a few pounds to hundreds per hour. It can dice potatoes, onions, apples, beets, turnips, celery, cucumbers and many other foods as efficiently as machines costing hundreds of dollars more. Many times faster than hand dicing, the Dicer Attachment is ideal for cutting French Fries too.\*

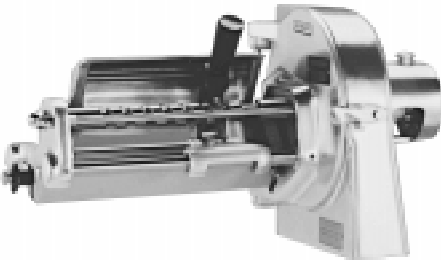

Restaurants and institutions will find this attachment invaluable. Delicatessens can produce a wide variety of profitable food items at lower cost, and produce departments can package and freeze diced vegetables.

The Dicer operates on the same back case as the 9" Vegetable Slicer, and attaches in seconds to any Hobart Mixer, Food Cutter, or small Chopper equipped with a No. 12 or No. 22 attachment hub.

The Dicer Attachment may also be used with the PD-35 Power Drive Unit (No. 12 hub size) for higher volume output.

\* Specify French Fry Deflector and Drive Connector accessory for French Fry cutting.

### PUSHER AND GRIDS AVAILABLE FOR DICING IN THESE SIZES (Color Coded for easy matching)

TO MAKE	EQUIPMENT REQUIRED	
	GRIDS & PUSHER	KNIFE
1/4" Cubes**	1/4" Size	4 Blades
3/8" Cubes	3/8" Size	3 Blades
1/2" Cubes	1/2" Size	2 Blades
3/4" Cubes	Blank Frame & 3/4" Size	2 Blades
1" Cubes	Blank Frame & 1/2" Size	1 Blade
French Fries Only	Your choice of size	French Fry deflector and drive connector

\*\*Available for use in special applications depending on nature of product.

## VS9 DICER ATTACHMENT

Listed by National Sanitation Foundation

Works in combination with new or existing VS9 vegetable slicing attachments. It is powered by Hobart mixers, food cutters or power drives.

The basic package (VS9DICE-1) includes the following parts needed to give your VS9 slicing/shredding attachment dicing capability.

- Latch (replaces existing backcase latch)
- Hinged insert (holds dicing grid)
- Drive shaft connector

The following grids and slicing plates are used in conjunction to give various size cuts.

- Dicing Grids (1/4", 3/8", 1/2")
- Serrated Dicing Grid 1/2" (Ideal for soft products)
- French Fry Grid (3/8")
- Slicing Plates (1/4", 3/8", 1/2")

## FLEXIBILITY . . .

Existing VS9 vegetable slicing attachments can easily be upgraded to use the VS9. A new/longer latch is permanently attached. Once this is installed, you can easily switch from slicing/shredding to dicing. Just add the dicing insert, drive shaft and slicing plate.

All parts can be disassembled without tools for fast sink cleanup.

## QUALITY . . .

With the DICE-1/2S serrated dicing grid, tomatoes can be diced with minimal scrap and juice. The other dicing and French Fry grids produce quality cuts of potatoes and other hard vegetables.

NOTE: Order the VS9DICE-2 for 1/2" tomato dicing. This is ideal for tacos.

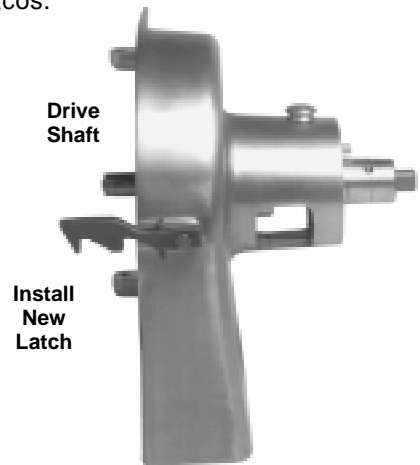

Drive Shaft

Install New Latch

### DRIVE SHAFT AND LATCH



Dicing Insert

Slicing Plate

### DICING INSERT WITH GRID AND SLICING PLATE



SHOWN WITH VS9 BACKCASE and HOPPER FRONT

**ADDITIONAL ATTACHMENTS AND ACCESSORIES FOR HOBART MIXERS**

A wide selection of practical attachments and accessories for Mixers, Food Cutters and small Choppers further increase their broad range of usefulness. These attachments meet specific needs and are constructed to operate with continued reliability.

**BOWL SPLASH COVER**



This is used to control splash of light ingredients during mixing operations. Thermoformed plastic only for 60 qt. bowls.

**BOWL EXTENSION RING**

Provides higher sidewalls for the bowl to prevent throw-out of certain ingredients. Does not increase bowl capacity.

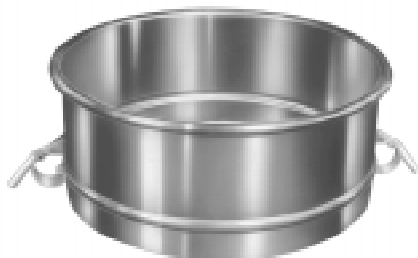

**BOWL JACKET**

Use for receiving mixtures from the Strainer/Colander, and also as an ice or hot water bowl jacket used with a standard mixer bowl.



**BOWL TRUCK**



Self-centering, with four rubber-tired wheels for easy portability when moving large bowls for floor model mixers.

**BOWL TRUCK ADAPTER**



For use with 30 and 40-quart bowl sizes of floor model mixers. Inserts easily into the standard bowl truck.

**SOUP STRAINER/COLANDER**

The colander bowl replaces the mixer bowl. Mixer agitator is replaced by a roller or brush assembly. Two disc screens, one brush and one roller are included.



The roller assembly is used for ricing potatoes or vegetables, making fine or coarse soup stock, and any other light



pressure operation. The brush assembly is used for removing pit or seeds from foods used to make jams, jellies and a variety of other applications. These assemblies contact the disc screen with a turning and rubbing action.

Optional jacket for bowl can be used to receive the mixture.

**BOWL SCRAPER**

The scraper is used in conjunction with the B Beater or Wire Whips. It is easily attached to the mounting bracket. While the agitator is mixing the product, the scraper is continuously scraping the whole inside of the mixer bowl. No more stopping mid-cycle to manually scrape down the sides of the bowl. The bowl scrapers are built to last and are made of urethane elastomer. The **NEW** optional bowl scraper is available for the following models: A200, D300, D330, D340, H600, L800, M802 and V1401. Patent Pending.

**NOTE:** Bowl scrapers should be used with Stainless Steel Bowls only.



H600 with Scraper Option - Bowl in down position



FOOD EQUIPMENT

# FOOD MACHINE ATTACHMENTS AND ACCESSORIES

## MEAT AND FOOD CHOPPER

Listed by National Sanitation Foundation



Turn meat and food trimmings into croquettes, meat patties or sausage with the use of this attachment. No kitchen should be without this important piece of equipment.

Hobart-designed, protective type spiral fluted chopping-end worm provides clean cutting action. There is no crushing or mashing of product; its natural color and flavor are retained.

## ADJUSTABLE TRAY SUPPORT

Designed for floor model mixers, this convenient tray support is constructed of sturdy, lightweight aluminum, and is adjustable to convenient work levels.

It may be used with the 9" Vegetable Slicer, Dicer Attachment or Meat and Food Chopper.



## AVAILABILITY AND FINISHES FOR FOOD MACHINE ATTACHMENTS AND ACCESSORIES

Model No.	9" Veg. Slicer	Speed Drive	Dicer	Meat & Food Chopper		Adj. Tray Support	Bowl (Qt. Cap.)	Bowl Splash Cover		Extension Ring		Bowl Truck (floor models only)		Bowl Truck Adapter	Food Strainer & Colander	Bowl Jacket
	Burn. Alum.	Burn. Alum.	Burn. Alum.	Tinned W/ Tinned Pan	Brite Metal With S/S Pan	Aluminum		Tinned	S/S	Tinned	S/S	Painted Cast Iron	Burn. Alum.	Burn. Alum.	Tinned	Tinned
<b>N-50 (#10 Hub)</b>				X***			5*									X
<b>A-120 (#12 Hub)</b>	X	X	X	X	X		12	X	X						X	X
<b>A-200 (#12 Hub)</b>	X	X	X	X	X	A-200F Floor Model Only	20	X	X			X				X
							12	X	X					X	X	
<b>D-300 (#12 Hub)</b>	X	X	X	X	X	X	30	X	X			X			X	X
							20	X	X					X	X	
<b>D-330 (#12 Hub)</b>	X	X	X	X	X	X	30	X	X	X	X		X		X	X
							20	X	X							
<b>D-340 (#12 Hub)</b>	X	X	X	X	X	X	40					X				
							30			X	X		X		X	X
							20	X	X							
<b>P-660 H-600 (#12 Hub)</b>	X	X	X	X	X	X	60	X		X	X	X	X			
							40†	X	X	X	X			X	X†	X
							30†	X	X	X	X			X	X	X
<b>L-800 (#12 Hub)</b>	X	X (#12 Hub)	X (#12 Hub)	X	X	X	80	X	X	X	X	X	X			
							60†	X		X	X	X	X			
							40†	X	X	X	X			X	X†	X
							30†	X	X	X	X			X	X	X
<b>M-802 (#12 Hub) Factory Install</b>	X (#12 Hub req'd)	X (#12 Hub)	X (#12 Hub req'd)	X	X	X	80	X	X	X	X	X	X			
							60†	X		X	X	X	X			
							40†	X	X	X	X			X	X†	X
							30†	X	X	X	X			X	X	X
<b>V-1401 (#12 Hub) Factory Install</b>	X (#12 Hub req'd)	X	X (#12 Hub req'd)	X	X	X	140	X	X			X	X			
							80†	X	X	X	X	X	X			
							60††	X		X	X	X	X			
							40††	X	X	X	X			X	X††	X
							30††	X	X	X	X			X	X	X

\* Stainless Steel only.

\*\*\* White Plastic, #10 Hub

† Bowl Adapter required

†† Two Bowl Adapters required — 140-80 and 80-60 or 80-40/30

**AGITATORS FOR HOBART MIXERS**



**B - FLAT BEATER**

Creaming, mixing cake and cookie batters, mashing potatoes, general mixing



**C - WING WHIP**

Whipping cream, eggs, sponges, light icings and marshmallow (4 wings - 12 thru 30 qt., 6 wings - 40 thru 140 qt.)



**D - WIRE WHIP**

Lighter whipping cream, eggs, light sponges, meringues



**I - HEAVY DUTY WIRE WHIP**

Mixing cake and cookie batters, whipping sponges, lighter marshmallows (Reinforcing band as shown on 80 and 140 qt. sizes only)



**J - WING BEATER**

Whipping marshmallow and heavy icings (Only used with 80 qt.)\*



**K - SPIRAL WHIP**

Sponge cakes, incorporating flour, light marshmallow (80 qt. only)\*

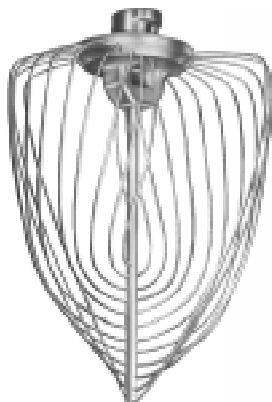

**Q - SPIRAL WHIP**

Foaming of light batches at high speed; quick incorporation of flour at low speed (140 qt. only)



**E - DOUGH ARM**

Doughs of ordinary consistency

**ED - DOUGH ARM**  
Bread, pizza and roll doughs; special doughs (20 to 140 qt.)\*

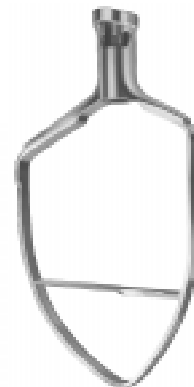

**P - PASTRY KNIFE**

Cutting shortening into flour

**S - SWEET DOUGH ARM**

Mixing sweet yeast doughs - combines rubbing/folding action



NOTE: "CH" Heavy Duty 6 Wing Whip – Not Shown, (Used with 140 qt. only)

\* Not NSF Listed



FOOD EQUIPMENT

# FOOD MACHINE ATTACHMENTS AND ACCESSORIES

## AVAILABILITY AND FINISHES FOR MIXER AGITATORS (See reverse side for illustrations)

Model No.	Bowls (Qt. Cap.)	B - Flat Beater		C - Wing Whip	D - Wire Whip	I - Heavy Duty Wire Whip	J - Wing Beater	E - Dough Arm	ED - Dough Arm	P - Pastry Knife	K - Spiral Whip	Q - Spiral Whip	S - Sweet Dough Arm
	Tinned & S/S	Alum.	S/S	Tinned	S/S Wires	S/S Wires	Bronze	Alum.	Alum.	Tinned	S/S Wires	S/S Wires	Alum.
<b>N-50</b>	5*	X	X		X*			X					
<b>A-120</b>	12	X	X	X	X			X		X			
<b>A-200</b>	20	X	X	X	X				X	X			X
	12	X	X		X			X					
<b>D-300</b>	30	X	X	X	X	X			X	X			X
	20	X	X	X	X			X		X			
<b>D-330</b>	30	X	X	X	X	X		X	X	X			X
	20	X	X	X	X			X		X			
<b>D-340</b>	40	X	X	X	X	X		X		X			X
	30	X	<sup>30/40</sup> X	<sup>30/40</sup> X	<sup>30/40</sup> X	<sup>30/40</sup> X		<sup>30/40</sup> X		<sup>30/40</sup> X			<sup>30/40</sup> X
	20	X	X	X	X			X		X			
<b>H-600 P-660</b>	60	X	X	X	X	X			X	X			X
	40	X	X	X	X	X		X		X			X
	30	X	X	X	X	X		X		X			X
<b>L-800</b>	80	X	X	X	X	X	X	X	X	X	X		X
	60	X	X	X	X	X			X	X			X
	40	X	X	X	X	X		X		X			X
	30	X	X	X	X	X		X		X			X
<b>M-802</b>	80	X	X	X	X	X	X	X	X	X	X		X
	60	X	X	X	X	X			X	X			X
	40	X	X	X	X	X		X		X			X
	30	X	X	X	X	X		X		X			X
<b>V-1401</b>	140	X	X	X(a)	X	X	X		X	X		X	X
	80	X	X	X	X	X	X	X	X	X	X		X
	60	X	X	X	X	X			X	X			X
	40	X	X	X	X	X		X		X			X
	30	X	X	X	X	X		X		X			X

\* All Stainless Steel only.  
(a) CH heavy duty wing whip also available.



EXECUTIVE OFFICES  
701 RIDGE AVENUE  
TROY, OHIO 45374-0001