

# F-1500M\_H-C

## MODULAR CUBELET ICE MACHINE

Item # \_\_\_\_\_

Project: \_\_\_\_\_

Qty: \_\_\_\_\_

\*AutoCad available on KCL

F-1500M\_H-C

I/13

Item # 13162

### CUBELET DIMENSIONS

W x D x H

**F-1500M\_H-C**  
30 x 27<sup>1/2</sup> x 34<sup>7/16</sup>



B-500



B-700

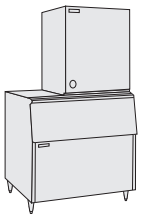

B-800

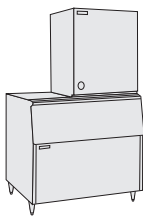

B-900

Also available on Large Bins:

B-1150SS

B-1300SS

B-1500SS

B-1650SS

### CUBELET DIMENSIONS

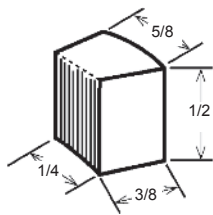

### F-1500MAH-C

Air-Cooled

Shown on an optional  
B-900

### F-1500MWH-C

Water-Cooled

### F-1500MRH-C

Remote Air-Cooled



- Up to 1335 lbs. of ice production per 24 hours
- Durable stainless steel exterior
- CleanCycle I2® Design 
- 15 minute flush cycle every 12 hours
- Removes sediment
- Cleaner ice
- Longer life and easy maintenance
- Removable air filters (Air-cooled model only)
- R-404A Refrigerant

\* The F-1500MRH-C is ENERGY STAR qualified.

### Warranty

Valid in United States, Canada, Puerto Rico, & U.S. Territories. Contact factory for warranty in other countries.

**Three Year** - Parts & Labor on entire machine. (Serial numbers Vxxxxxj and after.)

**Five Year** - Parts on: Compressor, air-cooled condenser coil.



ISO9001-15014E01

© HOSHIZAKI AMERICA, INC.

618 Hwy. 74 S., Peachtree City, GA 30269

TEL 1-800-438-6087

FAX 1-800-345-1325

www.hoshizaki.com



# Hoshizaki

# F-1500M\_H-C MODULAR CUBELET ICE MACHINE

**DIMENSIONS**  
W x D x H  
**F-1500M\_H-C**  
30 x 27<sup>1/2</sup> x 34<sup>7/16</sup>

- Air-cooled
- Water-cooled
- Remote Air-cooled

### AIR-COOLED

Water Temp° F.	50°	70°	90°
Air Temp° F. 70°	1300	1245	1194
Air Temp° F. 80°	1145	1099	1054
Air Temp° F. 90°	1011	<b>990</b>	930

### WATER-COOLED

Water Temp° F.	50°	70°	90°
Air Temp° F. 70°	1125	1075	1060
Air Temp° F. 80°	1050	1040	1025
Air Temp° F. 90°	1015	<b>975</b>	990

### REMOTE AIR-COOLED

Water Temp° F.	50°	70°	90°
Air Temp° F. 70°	1335	1294	1258
Air Temp° F. 80°	1223	1188	1155
Air Temp° F. 90°	1123	<b>1120</b>	1060

### UTILITY CONSUMPTION

Model Number	KWH per 100 LBS. 90/70	Potable Water Gal. per 100 lbs.
F-1500MAH-C	4.5	12.0
F-1500MWH-C	4.3	12.0
F-1500MRH-C	4.18	12.0

### SPECIFICATIONS

Model Number	Condenser	Amperage	Min. Circuit Ampacity	Shipping Weight
F-1500MAH-C	Air-Cooled	16.3	20	325 lbs.
F-1500MWH-C	Water-Cooled	15.9	20	325 lbs.
F-1500MRH-C	Remote Air-Cooled	18.9	20	325 lbs.

### STORAGE BINS

Model Number	Application Capacity	ARI-Rated Capacity
B-500	500 lbs.	360 lbs.
B-700	700 lbs.	550 lbs.
B-800	800 lbs.	600 lbs.
B-900	900 lbs.	660 lbs.
B-1150	1150 lbs.	N/A
B-1300	1275 lbs.	N/A
B-1500	1490 lbs.	N/A
B-1650	1605 lbs.	N/A

### ELECTRICAL & PLUMBING/F-1500M\_H-C

- 208-230V/60/1 (3 wire dedicated neutral for 115V)
- 20 amp Max Fuse/HACR Breaker Size
- 3/8" OD copper or equivalent independent water supply
- 3/4" FPT independent drain connection



© HOSHIZAKI AMERICA, INC.

618 Hwy. 74 S., Peachtree City, GA 30269

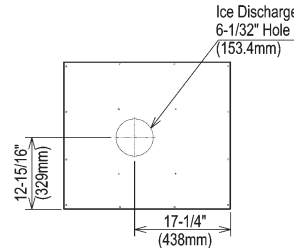

ICE DROP ZONE

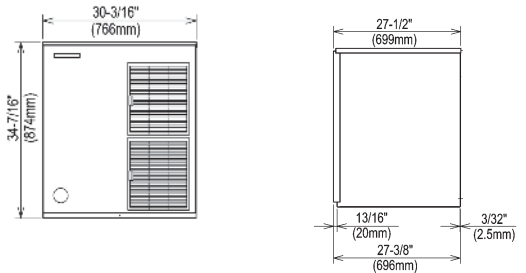

FRONT VIEW

SIDE VIEW

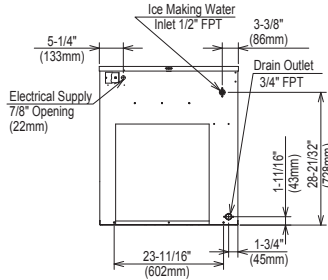

AIR-COOLED UNIT

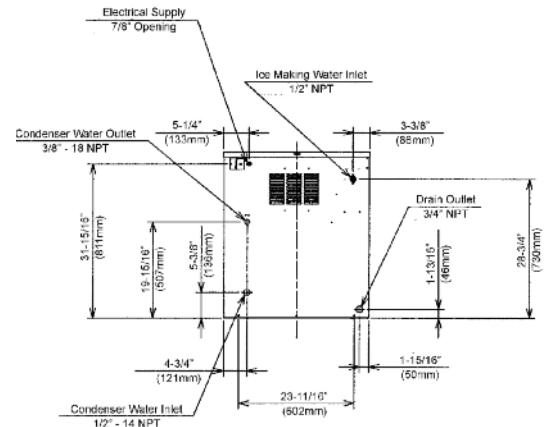

WATER COOLED UNIT

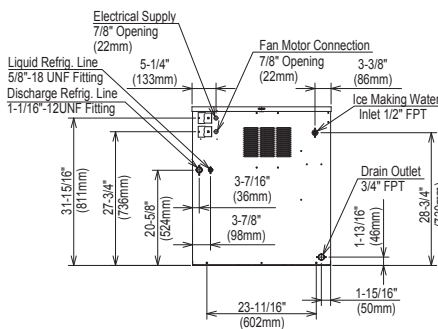

REMOTE AIR-COOLED UNIT

URC-14F Remote Condenser (Sold Separately)  
For Use with F-1500MRH-C

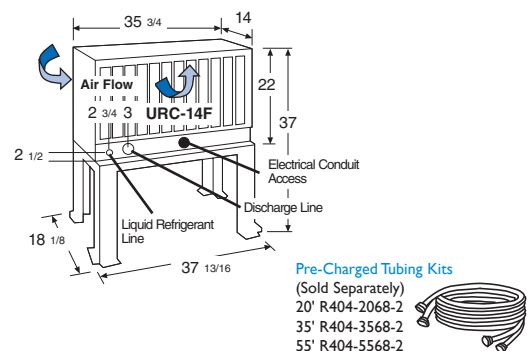

Pre-Charged Tubing Kits (Sold Separately)  
20' R404-2068-2  
35' R404-3568-2  
55' R404-5568-2

Voltage supply for the URC Remote Condenser is supplied from the Ice Maker.  
No additional circuit is required.

### OPERATING LIMITS

- Ambient Temp Range 45 - 100°F
- Water Temp Range 45 - 90°F
- Water Pressure 10 - 113psig
- Voltage Range 187 - 253V

### SERVICE

- Panels easily removed and all components accessible for service.
- Removable/cleanable air filter (Air-Cooled models only)

TEL 1-800-438-6087

FAX 1-800-345-1325

www.hoshizaki.com

Printed in U.S.A.

