

KM-2100/2500S_H3

3 PHASE STACKABLE ICE CUBER

Item # _____

Project: _____

Qty: _____

*AutoCad available on KCL

KM-2100/2500S_H3

I/13

Item # 13246

CUBER DIMENSIONS

W x D x H

KM-2100/2500S_H3
48 x 27^{3/8} x 36^{7/16}

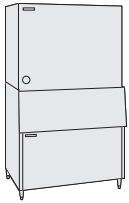

B-800

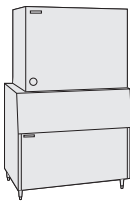

B-900

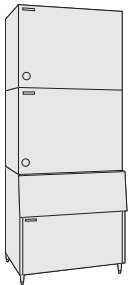

B-800

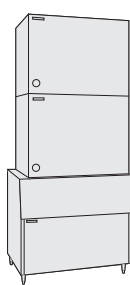

B-900

Also available on Large Bins:
B-1150SS
B-1300SS
B-1500SS
B-1650SS

KM CUBE DIMENSIONS

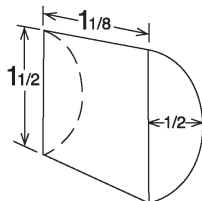

KM-2100SWH3

Water-Cooled 3 Phase
Shown on an optional
B-900

KM-2100SRH3

Remote Air-Cooled 3 Phase

KM-2500SWH3

Water-Cooled 3 Phase

KM-2500SRH3

Remote Air-Cooled 3 Phase





KM-2100S_H3

- Up to 2096 lbs. of ice production per 24 hours
- Stackable for 4192 lbs. per 24 hour ice production in the same floor space

KM-2500S_H3

- Up to 2424 lbs. of ice production per 24 hours
- Stackable for 4848 lbs. per 24 hour ice production in the same floor space

KM-2100S_H3 & KM-2500S_H3

- Durable stainless steel exterior
- Protected by H-GUARD Plus Antimicrobial Agent 
- CycleSaver® design 
- EverCheck® alert system 
- Individual crescent cube
- Stainless steel evaporator
- R-404A Refrigerant

Warranty

Valid in United States, Canada, Puerto Rico, & U.S. Territories. Contact factory for warranty in other countries.

Three Year - Parts & Labor on entire machine.

Five Year - Parts & Labor on: Evaporator.

Five Year - Parts on: Compressor, air-cooled condenser coil.



ISO9001-ISO14001



HOSHIZAKI

KM-2100/2500S_H3

3 PHASE STACKABLE ICE CUBER

DIMENSIONS

W x D x H

KM-2100S_H3

48 x 27^{3/8} x 36^{7/16}

KM-2500S_H3

48 x 27^{3/8} x 36^{7/16}

STACKABLE ICE CUBER

- Water-cooled 3 phase / Remote Air-cooled 3 phase
- Water-cooled 3 phase / Remote Air-cooled 3 phase

KM-2100 WATER - COOLED 3 PHASE

Water Temp° F.	50°	70°	90°
Air Temp° F.	70°	2096	2083
	80°	2086	2065
	90°	2083	2050

KM-2100 REMOTE AIR - COOLED 3 PHASE

Water Temp° F.	50°	70°	90°
Air Temp° F.	70°	2034	1968
	80°	1984	1882
	90°	1968	1810

KM-2500 WATER - COOLED 3 PHASE

Water Temp° F.	50°	70°	90°
Air Temp° F.	70°	2408	2395
	80°	2398	2379
	90°	2395	2365

KM-2500 REMOTE AIR - COOLED 3 PHASE

Water Temp° F.	50°	70°	90°
Air Temp° F.	70°	2424	2369
	80°	2382	2296
	90°	2369	2235

UTILITY CONSUMPTION

Model Number	Ice Production Per Cycle Lbs. Cubes	KWH per 100 LBS.	Potable Water Gal. per 100 lbs.	Condenser Water Gal. per 100 lbs.
KM-2100SWH3	46.8 2160	3.35	20.0	95
KM-2100SRH3	46.8 2160	4.26	21.1	N/A
KM-2500SWH3	46.3 2160	3.78	19.4	101
KM-2500SRH3	46.1 2160	4.50	18.6	N/A

SPECIFICATIONS

Model Number	Condenser	Amperage	Min. Circuit Ampacity	Shipping Weight
KM-2100SWH3	Water-Cooled	10.5	20	440 lbs.
KM-2100SRH3	Remote Air-Cooled	12.5	20	440 lbs.
KM-2500SWH3	Water-Cooled	14.2	30	415 lbs.
KM-2500SRH3	Remote Air-Cooled	17.7	30	440 lbs.

STORAGE BINS

Model Number	Application Capacity	ARI-Rated Capacity
B-800	800 lbs.	600 lbs.
B-900	900 lbs.	660 lbs.
B-1150	1150 lbs.	N/A
B-1300	1275 lbs.	N/A
B-1500	1490 lbs.	N/A
B-1650	1605 lbs.	N/A

ELECTRICAL & PLUMBING/KM-2100/2500S_H3

- 208 - 230V/60/3
- 20 amp Max Fuse (30 amp Max Fuse - KM-2500) HACR breaker size
- 1/2" FPT copper or equivalent independent potable water supply
- 3/4" FPT independent drain connection



© HOSHIZAKI AMERICA, INC.

618 Hwy. 74 S., Peachtree City, GA 30269

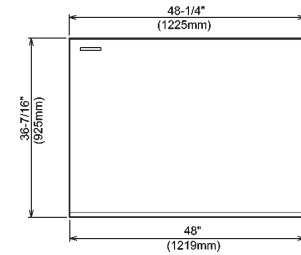

FRONT VIEW - KM-2100/2500

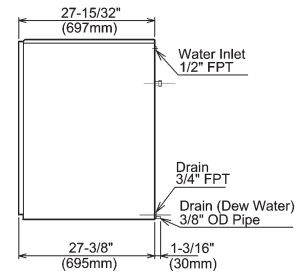

SIDE VIEW - KM-2100/2500

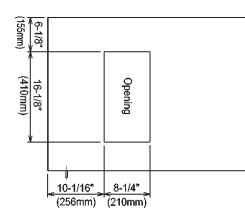

ICE DROP ZONE (BOTTOM VIEW - KM-2100/2500)

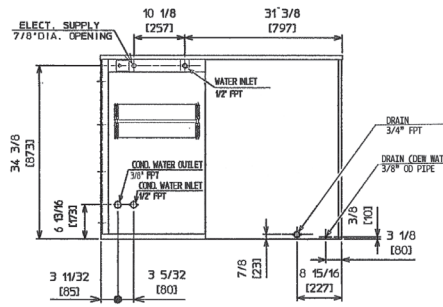

WATER-COOLED UNIT (REAR VIEW - KM-2100SWH3)

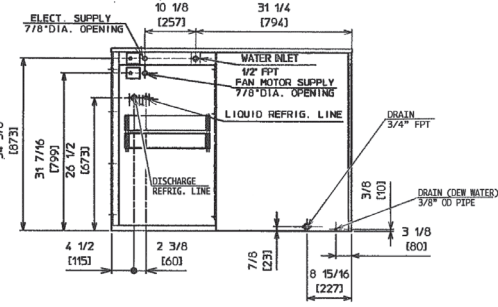

REMOTE AIR-COOLED UNIT (REAR VIEW - KM-2100SRH3)

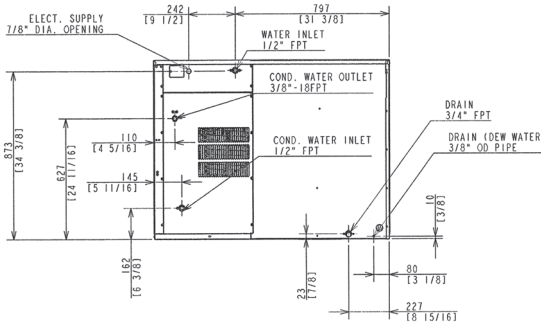

WATER-COOLED UNIT (REAR VIEW - KM-2500SWH3)

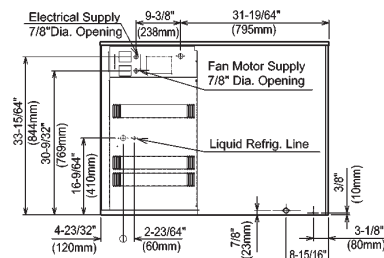

REMOTE AIR-COOLED UNIT (REAR VIEW - KM-2500SRH3)

URC-22 & 23F Remote Condenser (Sold Separately)
For Use with KM-2100SRH3 & KM-2500SRH3

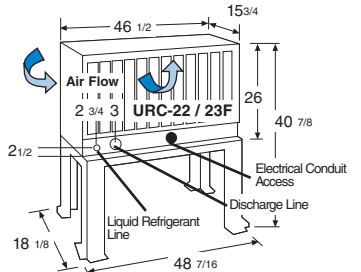

Voltage supply for the URC Remote Condenser is supplied from the Ice Maker. No additional circuit is required.

Pre-Charged Tubing Kits (Sold Separately)

- 20' R404A-20610-2
- 35' R404A-35610-2
- 55' R404A-55610-2



OPERATING LIMITS

- Ambient Temp Range 45 - 100°F
- Water Temp Range 45 - 90°F
- Water Pressure 10 - 113psig
- Voltage Range 187 - 253V

CONDENSING UNIT

- Voltage Range 104 - 127V
- Ambient Temp Range -20 - 122°F

SERVICE

- Panels easily removed and all components accessible for service.

TEL 1-800-438-6087

FAX 1-800-345-1325

www.hoshizaki.com

Printed in U.S.A.

