

KM-901M_H(3)

MODULAR CRESCENT CUBER

Item # _____

Project: _____

Qty: _____

*AutoCad available on KCL

KM-901M_H(3)

10/12

Item # 13223

CUBER DIMENSIONS

W x D x H

KM-901M_H(3)
30 x 27^{3/8} x 37^{7/16}

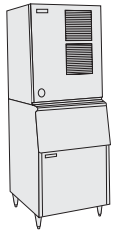

B-500

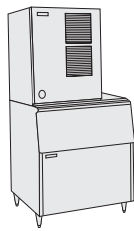

B-700

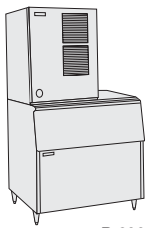

B-800

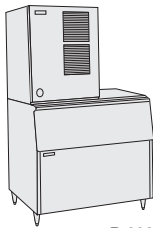

B-900

Also available on Large Bins:

B-1150SS
B-1300SS
B-1500SS
B-1650SS

KM CUBE DIMENSIONS

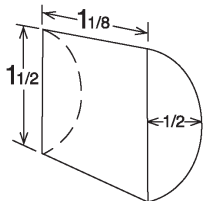

KM-901MAH

Air-Cooled

Shown on an optional
B-900

KM-901MWH

Water-Cooled



KM-901MRH

Remote Air-Cooled 1 Phase

KM-901MRH3

Remote Air-Cooled 3 Phase



- Up to 912 lbs. of ice production per 24 hours
- Durable stainless steel exterior
- Individual crescent cube
- Protected by H-GUARD Plus Antimicrobial Agent 
- CycleSaver® Design 
- EverCheck® alert system 
- Stainless steel evaporator
- Removable air filters (Air-cooled model only)
- R-404A Refrigerant



ISO 9001-5:2008

Warranty

Valid in United States, Canada, Puerto Rico, & U.S. Territories. Contact factory for warranty in other countries.

Three Year - Parts & Labor on entire machine.

Five Year - Parts & Labor on: Evaporator.

Five Year - Parts on: Compressor, air-cooled condenser coil.



Hoshizaki

DIMENSIONS
W x D x H
KM-901M_H(3)
30 x 27^{3/8} x 37^{7/16}

KM-901M_H(3) MODULAR CRESCENT CUBER

- Air-cooled
- Water-cooled
- Remote Air-cooled 1 Phase
- Remote Air-cooled 3 Phase

AIR-COOLED

Water Temp° F.	50°	70°	90°
Air Temp° F. 70°	874	832	785
Air Temp° F. 80°	842	778	736
Air Temp° F. 90°	832	732	687

WATER-COOLED

Water Temp° F.	50°	70°	90°
Air Temp° F. 70°	912	887	849
Air Temp° F. 80°	893	854	815
Air Temp° F. 90°	887	827	787

REMOTE AIR-COOLED 1 PHASE / 3 PHASE

Water Temp° F.	50°	70°	90°
Air Temp° F. 70°	889 / 899	859 / 874	803 / 817
Air Temp° F. 80°	866 / 880	818 / 842	755 / 772
Air Temp° F. 90°	859 / 874	785 / 815	724 / 749

UTILITY CONSUMPTION

Model Number	Ice Production Per Cycle		KWH per 100 LBS. 90/70	Potable Water Gal. per 100 lbs. 90/70	Condenser Water Gal. per 100 lbs. 90/70
	Lbs.	Cubes			
KM-901MAH	13.6	720	5.6	19.6	N/A
KM-901MWH	13.4	720	4.5	21.9	139
KM-901MRH	13.5	720	5.4	19.3	N/A
KM-901MRH3	14.2	720	5.4	18.0	N/A

SPECIFICATIONS

Model Number	Condenser	Amperage	Min. Circuit Ampacity	Shipping Weight
KM-901MAH	Air-Cooled	11.4	20	256 lbs.
KM-901MWH	Water-Cooled	8.7	15	249 lbs.
KM-901MRH	Remote A-C 1 Phase	11.6	20	249 lbs.
KM-901MRH3	Remote A-C 3 Phase	7.0	20	258 lbs.

STORAGE BINS

Model Number	Application Capacity	ARI-Rated Capacity
B-500	500 lbs.	360 lbs.
B-700	700 lbs.	550 lbs.
B-800	800 lbs.	600 lbs.
B-900	900 lbs.	660 lbs.
B-1150	1150 lbs.	N/A
B-1300	1275 lbs.	N/A
B-1500	1490 lbs.	N/A
B-1650	1605 lbs.	N/A

ELECTRICAL & PLUMBING/KM-901M_H(3)

- 208-230V/60/1 (3 wire with dedicated neutral for 115V) / (208-230/60/3)
- 20 amp Max Fuse/HACR Breaker Size - Air-cooled units
- 15 amp Max Fuse/HACR Breaker Size - Water-cooled unit
- 1/2" OD copper or equivalent independent potable water supply
- 3/4" FPT independent drain connection



© HOSHIZAKI AMERICA, INC.

618 Hwy. 74 S., Peachtree City, GA 30269

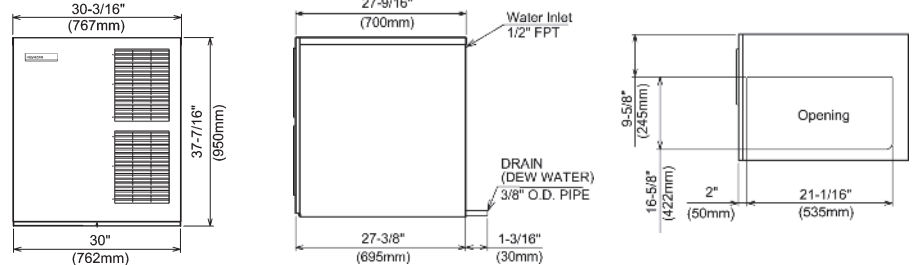

FRONT VIEW

SIDE VIEW

ICE DROP ZONE

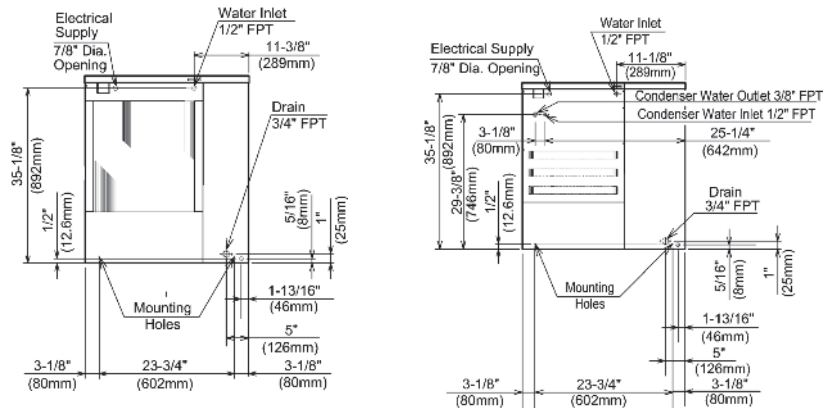

AIR-COOLED UNIT

WATER-COOLED UNIT

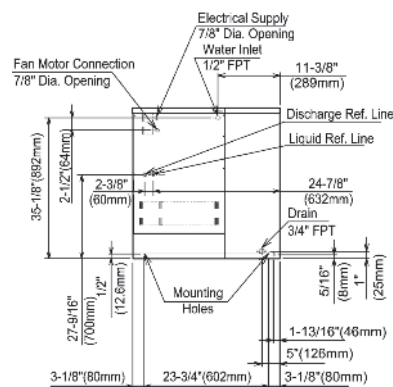

REMOTE AIR-COOLED UNIT (1 & 3 PHASE)

URC-9F Remote Condenser (Sold Separately)
For Use with KM-901MRH & KM-901MRH3

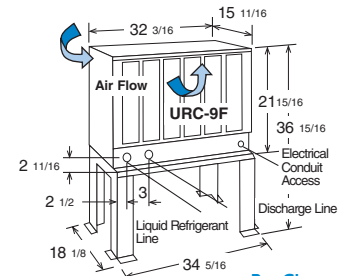

Pre-Charged Tubing Kits

(Sold Separately)
20' R404-2068-2
35' R404-3568-2
55' R404-5568-2



Voltage supply for the URC Remote Condenser is supplied from the Ice Maker. No additional circuit is required.

OPERATING LIMITS

- Ambient Temp Range 45 - 100°F
- Water Temp Range 45 - 90°F
- Water Pressure 10 - 113psig
- Voltage Range 187 - 253V

CONDENSING UNIT

- Voltage Range 104 - 127V
- Ambient Temp Range -20 - 122°F

SERVICE

- Panels easily removed and all components accessible for service.
- Removable/cleanable air filters (Air-Cooled model only)

TEL 1-800-438-6087

FAX 1-800-345-1325

www.hoshizaki.com

Printed in U.S.A.

