

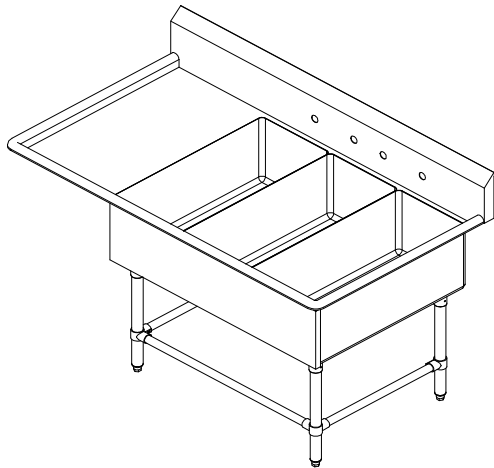

"3PBPS1431-1DB" Pro-Bowl Sinks - 16 Gauge

Three Compartment Sinks w/ 1 Drainboard
w/ Stainless Steel Base & Bracing

AUTOQUOTES



STANDARD: 16 ga. 300 S/S welded Bowls
16 ga. 300 S/S Drainboard and Splash
10" Back Splash
12" or 14" Deep Bowls

16 GAUGE 12" Deep		16 GAUGE 14" Deep	
	Qty		Qty
3PBPS1431-1D18		3PBPS14314-1D18	
3PBPS1431-1D24		3PBPS14314-1D24	
3PBPS1431-1D30		3PBPS14314-1D30	

**Must specify Left or Right
Drainboards**

Bowl Size:

14" X 31"

FEATURES:

- * Standard 16 Gauge
Type 300 stainless steel with # 4 polish, satin finish
- * 12" & 14" Deep Bowls
- * All Corners, both vertical and horizontal, covered at 5/8" radius
- * Bottoms of bowls formed for drainage to 3-1/2" diameter die stamped opening
- * Full length **10" High Boxed Backsplash**, with 2" return to wall at 45 degree and 3/4" turned down rear lip
- * 1-1/8" Faucet Holes in Backsplash
- * Solid Stainless Steel front panel, type 300 stainless steel with # 4 polish, satin finish
- * All outside corners of assembly are Bullnosed to provide safe, clean and polished edge
- * Standard legs 1-5/8" diameter, 16 gauge stainless steel
- * Legs located directly under sink bowls, providing increased stability and maximum weight support

CONSTRUCTION:

- Top: Stainless Steel Sinks are TIG welded, Exposed welds are polished to match adjacent surface.
- Bases: Stainless Steel Bases, Standard K.D.

MATERIAL:

- Bowls & 16 gauge stainless Steel
- Top: Type 300 stainless steel with # 4 polish, satin finish
- Legs: 1 5/8" Round O.D., 16 gauge stainless steel
- Bracing: 1 1/4" Round O.D., 16 gauge stainless steel
- Gussets: Stainless Steel
- Feet: 1" adjustable stainless steel bullet feet

**OPTIONAL
ACCESSORIES**

	Qty
END SPLASHS, RIGHT , LEFT or BOTH	
FAUCETS	
ADD-A-FAUCETS	
PRE-RINSE UNITS	
LEVEL WASTE	
OVERSHELVES	
POT RACK	

John Boos & Co

3601 S. Banker Street - Effingham, IL 62401
Phone: 217-347-7701 - Fax: 217-347-7705
Email: sales@johnboos.com - Web-site: www. johnboos.com

DETAILED SPECIFICATIONS

BOWLS	F	G	H
14 X 31	36-1/2"	31"	18-7/16"

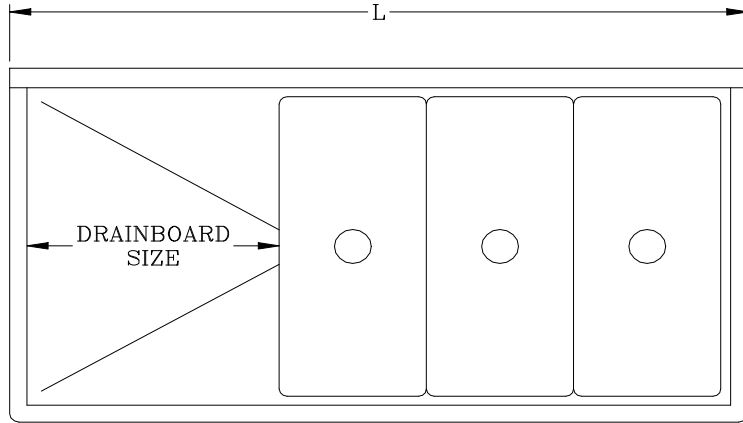
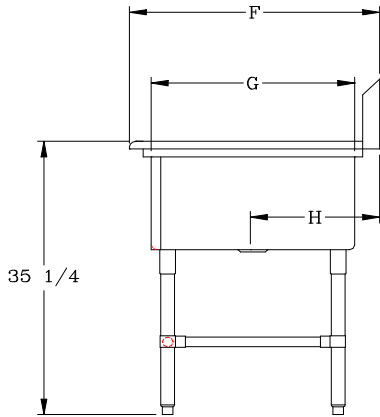

16 GAUGE * 12" DEEP				
MODEL	BOWL SIZE	DIMENSIONS	DB	WT.
3PBPS1431-1D18	14 X 31 X 12	64-3/16" X 36-1/2"	18"	367
3PBPS1431-1D24	14 X 31 X 12	70-3/16" X 36-1/2"	24"	380
3PBPS1431-1D30	14 X 31 X 12	76-3/16" X 36-1/2"	30"	396

	12" Deep	14" Deep
A	14"	16"
B	12"	14"
C	10"	10"
D	43"	43"

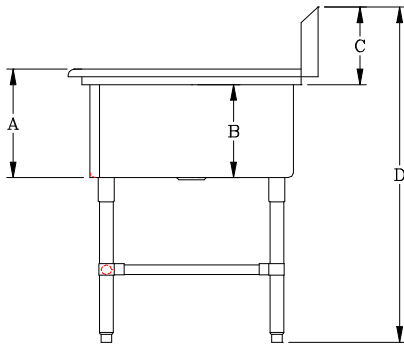

16 GAUGE * 14" DEEP				
MODEL	BOWL SIZE	DIMENSIONS	DB	WT.
3PBPS14314-1D18	14 X 31 X 14	64-3/16" X 36-1/2"	18"	376
3PBPS14314-1D24	14 X 31 X 14	70-3/16" X 36-1/2"	24"	389
3PBPS14314-1D30	14 X 31 X 14	76-3/16" X 36-1/2"	30"	405

All dimensions are typical.
 Tolerance +/- .500".
 All units ship unassembled for reduced shipping cost.

John Boos & Co

2601 S. Banker Str - Effingham, IL 62401 Phone: 217-347-7701 - Fax: 217-347-7705
 Email: sales@johnboos.com - Web-site: www.johnboos.com



July 2013

John Boos is constantly engaged in a program of improving products and therefore reserves the right to change specification without prior notice