

# Underbar Sinks

Item #	_____	Qty	_____
Model #	_____		
Project	_____		



**Shown with Faucet  
Model  
PBF-4-D-10**

\*\* Weights are subject to additional packaging

**EUB4S72-2D**  
**EUB4S84-2D**  
**EUB4S96-2D**

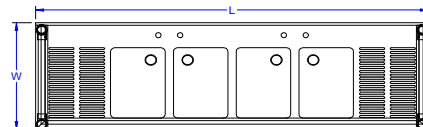

**EUB3S60-2D**  
**EUB3S72-2D**  
**EUB3S84-2D**  
**EUB3S96-2D**

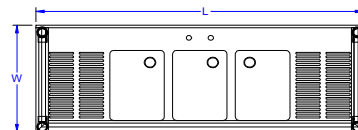

## BAR SINKS

MODEL #	Length	Width	BD	Height	Weight
EUB2S36-1RD	36"	21"	12"	30"	41
EUB2S36-1LD	36"	21"	12"	30"	41
EUB2S48-1RD	48"	21"	24"	30"	69
EUB2S48-1LD	48"	21"	24"	30"	69
EUB2S48-2D	48"	21"	13"	30"	69
EUB3S40	40"	21"	-	30"	60
EUB3S48-1RD	48"	21"	13"	30"	75
EUB3S48-1LD	48"	21"	13"	30"	75
EUB3S60-1RD	60"	21"	25"	30"	92
EUB3S60-1LD	60"	21"	25"	30"	92
EUB3S60-2D	60"	21"	13"	30"	92
EUB3S72-2D	72"	21"	19"	30"	102
EUB3S84-2D	84"	21"	25"	30"	109
EUB3S96-2D	96"	21"	31"	30"	124
EUB4S72-2D	72"	21"	13"	30"	104
EUB4S84-2D	84"	21"	19"	30"	120
EUB4S96-2D	96"	21"	25"	30"	135

**EUB3S48-1RD**  
**EUB3S48-1LD**  
**EUB3S60-1RD**  
**EUB3S60-1LD**

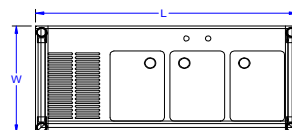

**EUB2S48-1RD**  
**EUB2S48-1LD**

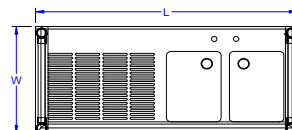

**EUB2S48-2RD**

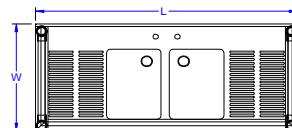

**EUB2S36-1RD**  
**EUB2S36-1LD**

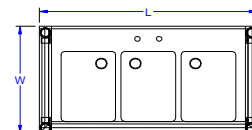
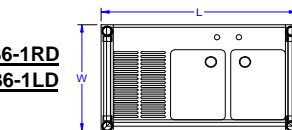

**EUB3S40**

RD = Right Drain board

LD = Left Drain board

### FEATURES:

- Fabricated Bowls, 10" x 14" x 10"
- Stamped Ribbed Drain boards
- Raised Marine Edge on Front & Sides
- Galvanized Legs and bracing, with adjustable bullet feet

### CONSTRUCTION:

Top: Stainless Steel Tops are TIG welded, Exposed welds are polished to match adjacent surface.

### MATERIAL:

- Top: 18 Gauge type 300 stainless steel
- Bracing: Galvanized
- Legs: Galvanized
- Gussets: Galvanized
- Feet: Plastic

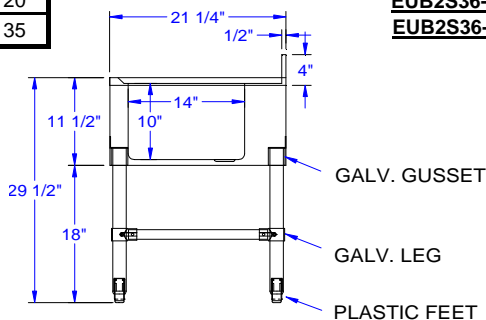

**INCLUDES:** Economy Faucet & Overflow Pipes  
Faucet Model - **PBF-4-D-10**  
Overflow Pipe Model - **PB-OVF-BS**

### OPTIONAL ACCESSORIES

	Qty
Speed Rail	
S/S Legs	

## John Boos & Co

3601 S. banker Street - Effingham, IL 62401  
Phone: 217-347-7701 - Fax: 217-347-7705  
Email: sales@johnboos.com - Web-site: www. johnboos.com

AUTOQUOTES



July 1, 2013