



"ST6-GSK" Stainless Steel Top Work Tables

w/ 16 Gauge Stainless Steel Work Top
w/ Galvanized Base & Adjustable Undershaft



Item #	_____	Qty	_____
Model #	_____		
Project	_____		

16 GAUGE TOP w/ ADJUSTABLE UNDERSHELF					
24"WIDE	Qty	30"WIDE	Qty	36"WIDE	Qty
ST6-2436GSK		ST6-3036GSK		ST6-3636GSK	
ST6-2448GSK		ST6-3048GSK		ST6-3648GSK	
ST6-2460GSK		ST6-3060GSK		ST6-3660GSK	
ST6-2472GSK		ST6-3072GSK		ST6-3672GSK	
ST6-2484GSK		ST6-3084GSK		ST6-3684GSK	
ST6-2496GSK		ST6-3096GSK		ST6-3696GSK	
ST6-24108GSK		ST6-30108GSK		ST6-36108GSK	
ST6-24120GSK		ST6-30120GSK		ST6-36120GSK	

FEATURES:

- * 16 Gauge Stainless Steel Top
Type 300 stainless steel with # 3 polish, satin finish
- * Top is **Sound Deadened**
- * Reinforced with 1"x2" channel running entire length of table
- * 1 1/2" **Stallion Edge** on front and rear with side edges 90 degree bend down for table line-up
- * Galvanized Base with **Adjustable** Undershaft
- * Adjustable bullet feet
- * Shipped knocked-down, easy - to - assemble
- * NSF Approved



CONSTRUCTION:

Top: Stainless Steel Tops are TIG welded, Exposed welds are polished to match adjacent surface.

MATERIAL:

Top: 16 gauge stainless steel
Type 300 stainless steel with # 3 polish, satin finish

Shelf: 18 gauge galvanized steel
** 36" Wide Tables, 16 Gauge Lower Shelf

Legs: 1 5/8" Round O.D., 16 gauge tubular galvanized steel

Gussets: Galvanized Steel

Feet: 1" adjustable galvanized bullet feet

OPTIONAL ACCESSORIES

	MODEL #	Qty
DRAWER		
DRAWER LOCK		
CASTERS		
OVERSHELVES		
SINKS		
POT RACK		

John Boos & Co

315 South First Street - Effingham, IL 62401
Phone: 217-347-7701 - Fax: 217-347-7705
Email: sales@johnboos.com - Web-site: www. johnboos.com

DETAILED SPECIFICATIONS

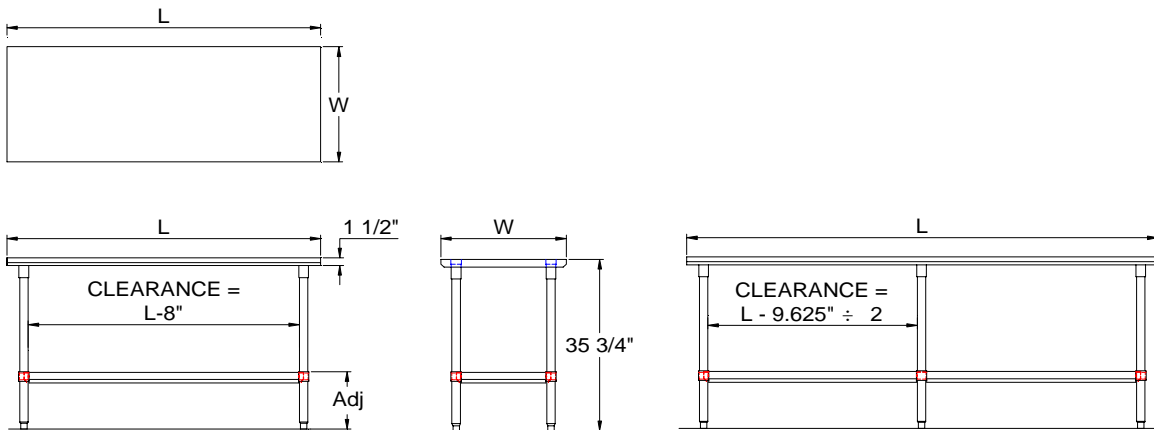

All units ship unassembled for reduced shipping cost.
 Units 7 ft. and larger are furnished with six legs.
 All dimensions are typical.
 Tolerance +/- .500".

Finished size of undershelf.
 Shelf length = length minus 4.875"
 Shelf width = width minus 4.25"

16 GAUGE TOP & UNDERSHELF

L	24" WIDE	WT.	30" WIDE	WT.	36" WIDE	WT.
36	ST6-2436GSK	52	ST6-3036GSK	59	ST6-3636GSK	75
48	ST6-2448GSK	64	ST6-3048GSK	76	ST6-3648GSK	82
60	ST6-2460GSK	76	ST6-3060GSK	92	ST6-3660GSK	98
72	ST6-2472GSK	97	ST6-3072GSK	111	ST6-3672GSK	144
84	ST6-2484GSK	108	ST6-3084GSK	125	ST6-3684GSK	135
96	ST6-2496GSK	118	ST6-3096GSK	139	ST6-3696GSK	155
108	ST6-24108GSK	130	ST6-30108GSK	153	ST6-36108GSK	171
120	ST6-24120GSK	142	ST6-30120GSK	167	ST6-36120GSK	187

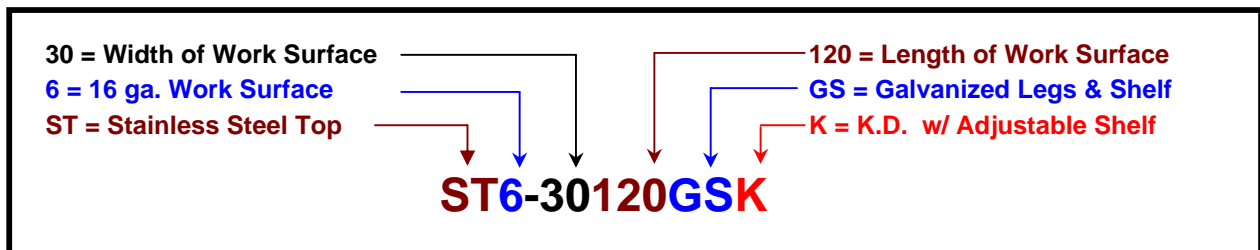

John Boos & Co

315 South First - Effingham, IL 62401 Phone: 217-347-7701 - Fax: 217-347-7705
 Email: sales@johnboos.com - Web-site: www.johnboos.com



March 2011

John Boos is constantly engaged in a program of improving products and therefore reserves the right to change specification without prior notice