

ITEM NO. \_\_\_\_\_  
 PROJECT \_\_\_\_\_  
 LOCATION \_\_\_\_\_  
 DATE \_\_\_\_\_ QTY. \_\_\_\_\_



## KSU SERIES Undercounter/Worktable Refrigerators & Freezers

### REFRIGERATORS

- KSUR27
- KSUR36
- KSUR48
- KSUR60
- KSUR72

### FREEZERS

- KSUF27
- KSUF48
- KSUF60

ENERGY STAR® qualification applies to undercounter refrigerator models only.

## FEATURES

### CONSTRUCTION

- Curved corner design creates a stylish appearance and reduces chances of injury in slip-and-fall accidents
- Stainless steel interior and exterior
- Foamed-in-place with low ODP polyurethane insulation
- Wall thickness: 2"
- 6" diameter casters
- Adjustable heavy-duty vinyl-coated shelves

### DOORS

- Self-closing
- Standard door swing configuration:
  - 1-door models ..... hinged right
  - 2-door models.....left hinged left, right hinged right

- 3-door model.....left hinged left, middle door hinged left, right door hinged right

### Door width:

- KSUR/KSUF27 ..... 27<sup>1</sup>/<sub>4</sub>"
- KSUR36 ..... 18"
- KSUR/KSUF48..... 23<sup>7</sup>/<sub>8</sub>"
- KSUR/KSUF60..... 30"
- KSUR72 ..... 23<sup>7</sup>/<sub>8</sub>"

### REFRIGERATION

- Self-contained forced air refrigeration system
- Refrigerant:
  - KSUR models & KSUF27 ..... R-134a
  - All other KSUF models ..... R-404A
- Temperature range:
  - KSUR ..... 32° to 40°F (0° to 4°C)
  - KSUF ..... -1° to -11°F (-18° to -24°C)

### WARRANTY

- **Standard limited three year parts and labor**
- **Additional two year coverage on compressor part**

## OPTIONS

- Low profile casters for ADA compliance
- Single or double overshelf
- Refrigerated drawers (excluding KSUR36)

## BID SPECIFICATIONS

Item no. KSU \_\_\_\_\_. Provide \_\_\_\_\_ Undercounter/worktable refrigerator/freezer(s), Master-Bilt model no. KSU \_\_\_\_\_.

Undercounter will feature rounded corner construction with stainless steel interior and exterior.

The refrigeration system will be bottom

mounted and self-contained. Freezers will use R-404A refrigerant, except for KSUF27 which will use R-134a. Refrigerators will use R-134a. The temperature range will be 32° to 40°F (0° to 4° C) for refrigerators and -1° to -11°F (-18° to -24°C) for freezers.

Undercounter to have standard limited

three year parts and labor with additional two year coverage on compressor part.

Undercounter to be UL, C-UL and ETL Sanitation listed with ENERGY STAR qualification on undercounter refrigerator models.

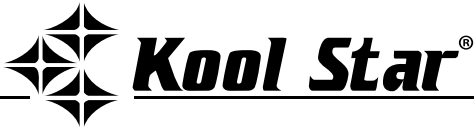

## TECHNICAL SPECIFICATIONS

MODEL	DIMENSIONS (in.)			DIMENSIONS (mm)			VOLTS	AMPS	UNIT H.P.	NO. OF DOORS	NO. OF SHELVES	CAP. CU. FT.	SHIP CU. FT.	SHIP WT. (LB/KG)
	L	D	H*	L	D	H*								
<b>REFRIGERATORS</b>														
KSUR27	27 <sup>1/2</sup>	30	35 <sup>7/8</sup>	699	762	911	115	3.2	1/5	1	1	7.0	21.1	199/90
KSUR36	36 <sup>3/8</sup>	30	35 <sup>7/8</sup>	924	762	911	115	3.6	1/5	2	2	9.4	26.6	242/110
KSUR48	48 <sup>1/4</sup>	30	35 <sup>7/8</sup>	1226	762	911	115	7.9	3/8	2	2	13.0	35.9	280/127
KSUR60	60 <sup>3/8</sup>	30	35 <sup>7/8</sup>	1534	762	911	115	7.9	3/8	2	2	16.5	44.2	333/151
KSUR72	72 <sup>3/8</sup>	30	35 <sup>7/8</sup>	1838	762	911	115	8.1	3/8	3	3	20.0	52.2	384/175
<b>FREEZERS</b>														
KSUF27	27 <sup>1/2</sup>	30	35 <sup>7/8</sup>	699	762	911	115	8.3	3/8	1	1	7.0	21.1	207/94
KSUF48	48 <sup>1/4</sup>	30	35 <sup>7/8</sup>	1226	762	911	115	8.9	1/2	2	2	13.0	35.9	298/135
KSUF60	60 <sup>3/8</sup>	30	35 <sup>7/8</sup>	1534	762	911	115	8.9	1/2	2	2	16.5	44.2	350/159

\*Height includes casters.

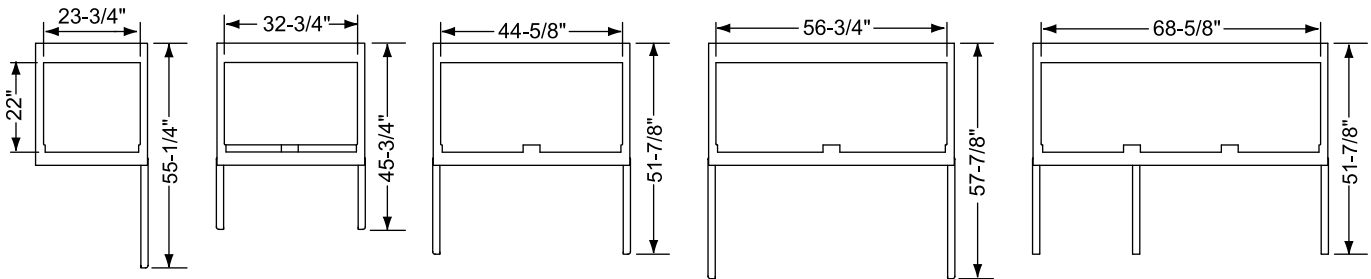

KSUR/KSUF27  
PLAN VIEW

KSUR36  
PLAN VIEW

KSUR/KSUF48  
PLAN VIEW

KSUR/KSUF60  
PLAN VIEW

KSUR72  
PLAN VIEW

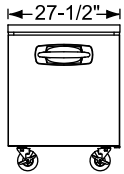

KSUR/KSUF27  
ELEVATION  
VIEW

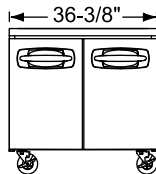

KSUR36  
ELEVATION  
VIEW

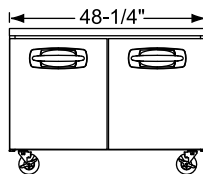

KSUR/KSUF48  
ELEVATION  
VIEW

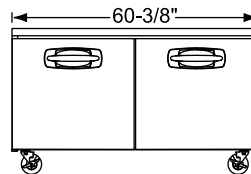

KSUR/KSUF60  
ELEVATION  
VIEW

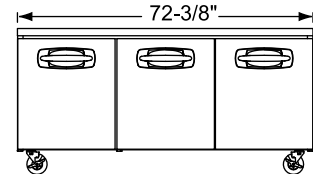

KSUR72  
ELEVATION  
VIEW

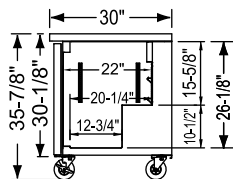

ALL MODELS  
SIDE VIEW

## LISTINGS



ENERGY STAR® qualification applies only to undercounter refrigerator models.

## HOOKUP

All models via plug in, 9 foot long flexible three wire 14/3 cord with molded plug.

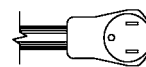

NEMA 5-15P



**OPTIONAL REFRIGERATED DRAWER CONFIGURATIONS (Not available on KSSMP36-15 model)**

KSUR models only, not available on KSUR36.

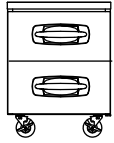

KSUR27-001

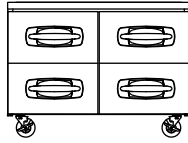

KSUR48-001

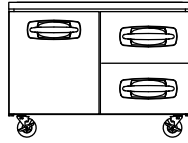

KSUR48-002

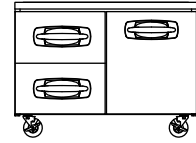

KSUR48-003

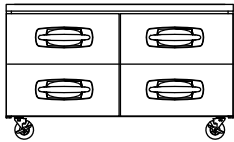

KSUR60-001

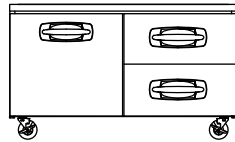

KSUR60-002

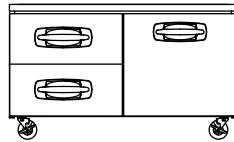

KSUR60-003

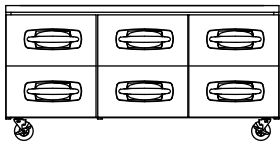

KSUR72-001

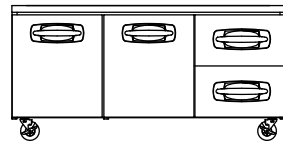

KSUR72-002

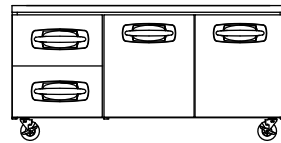

KSUR72-003

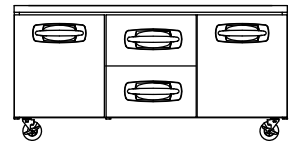

KSUR72-004

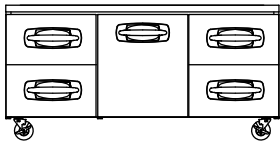

KSUR72-005

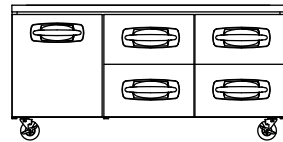

KSUR72-006

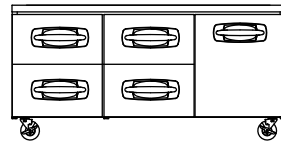

KSUR72-007

**PAN CONFIGURATIONS FOR REFRIGERATED DRAWERS (Not available on KSSMP36-15 model)**

KSUR models only, not available on KSUR36.

KSSP27, KSSMP27 & KSUR27

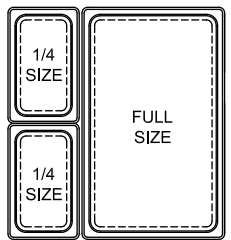

DRAWER FRONT

TOP DRAWER

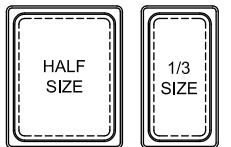

BOTTOM DRAWER

KSSP48, KSSMP48 & KSUR48  
& KSSP72, KSSMP72, MBUR72

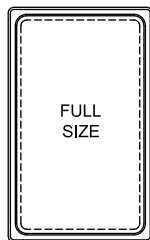

DRAWER FRONT

TOP DRAWER

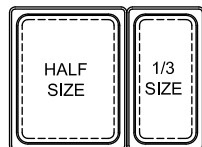

BOTTOM DRAWER

KSSP60, KSSMP60 & KSUR60

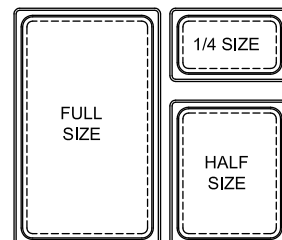

DRAWER FRONT

TOP DRAWER

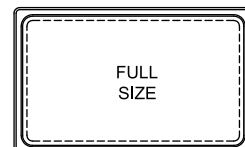

BOTTOM DRAWER

\*U.S. size pans, pans provided by others. Drawers accept up to 6-inch deep pans.

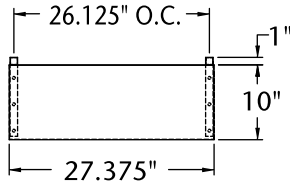
**OPTIONAL OVERSHELF SPECIFICATIONS**

PLAN VIEW  
KSSP27, KSSMP27,  
KSUR/KSUF27

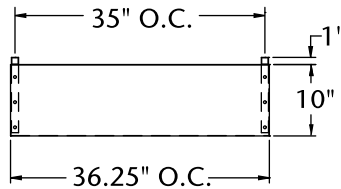

PLAN VIEW  
KSSP36, KSSMP36,  
KSUR36

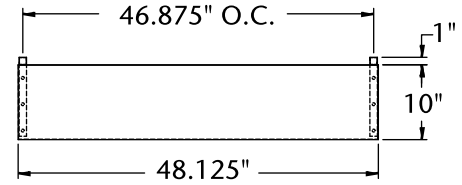

PLAN VIEW  
KSSP48, KSSMP48,  
KSUR/KSUF48

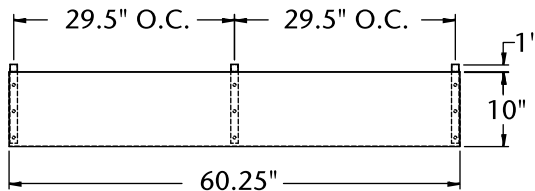

PLAN VIEW  
KSSP60, KSSMP60, KSUR/KSUF60

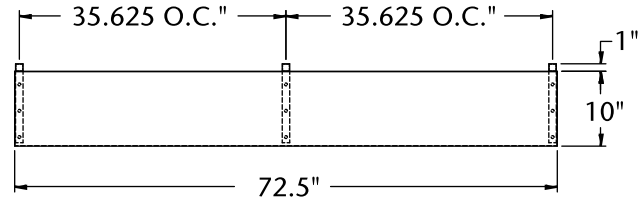

PLAN VIEW  
KSSP72, KSSMP72, KSUR72

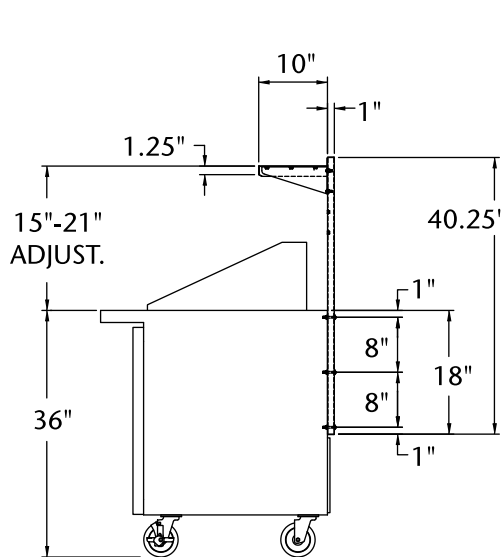

SINGLE SHELF SIDE VIEW

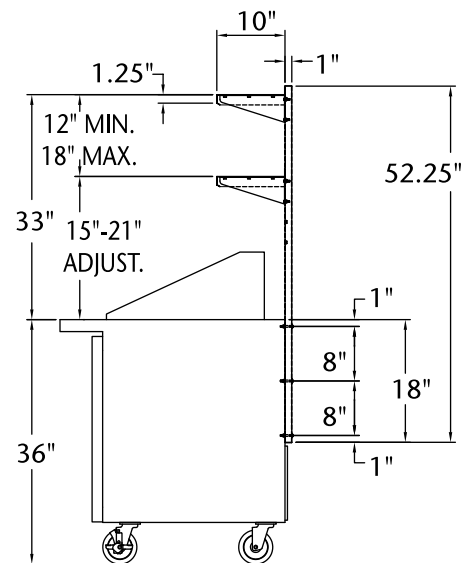

DOUBLE SHELF SIDE VIEW

**NOTE: Cabinet designed for optimum performance in air-conditioned area at 75°F ambient and 55% relative humidity.  
All specifications subject to change without notice.**