

MBPT SERIES

Pizza Prep Units



MBPT67



MODELS

- MBPT44 MBPT67 MBPT93

Drop-in section:

- Fans force cold air into this enclosed area keeping stored food items consistently cold
- A stainless steel divider prevents food spillage into the storage area beneath
- Accommodates 6" deep pans (4" standard)

FEATURES

CONSTRUCTION

- Stainless steel interior and exterior
- Foamed-in-place with low ODP polyurethane insulation
- Wall thickness: 1.75"
- Insulated top lids
- 1/2" thick, 19" deep reversible cutting board
- Standard 1/3 size pans
- Adjustable heavy-duty vinyl-coated shelves
- 6" diameter casters

DOORS

- Self-closing
- Heavy-duty ergonomic handle
- Standard door swing configuration:
 - MBPT44 hinged left
 - MBPT67 left hinged left, right hinged right
 - MBPT93 left hinged left, middle hinged left, right hinged right

Door width:

- MBPT44 29⁷/₈"
- MBPT67 and MBPT93 26"

REFRIGERATION

- Self-contained forced air refrigeration system
- Coated evaporator coils
- Refrigerant:
 - MBPT44 and MBPT67 R134a
 - MBPT93 R404A
- Temperature range: 32° to 40°F (0° to 4° C)

WARRANTY

- **Standard limited three year parts and labor**
- **Additional two year coverage on compressor part**

OPTIONS

- Single or double overshelf



- Refrigerated drawers



BID SPECIFICATIONS

Item no. MBPT____. Provide ____ Pizza Prep Unit(s), Master-Bilt model no. MBPT____.

Prep unit will be constructed of stainless steel interior and exterior. Standard features will include a 1/2" thick, 19" deep reversible cutting board, 1/3 size pans, insulated lids,

adjustable heavy-duty vinyl-coated shelves and 6" diameter casters.

The refrigeration system will be self-contained. MBPT44 and MBPT67 will contain R-134a refrigerant while the MBPT93 will contain R404A. The temperature range will be

32° to 40°F (0° to 4° C).

Prep unit to have standard limited three year parts and labor with additional two year coverage on compressor part.

Prep unit to be UL, C-UL and ETL Sanitation listed.

TECHNICAL SPECIFICATIONS

MODEL	DIMENSIONS (in.)			DIMENSIONS (mm)			VOLTS	AMPS	UNIT H.P.	NO. OF DOORS	NO. OF SHELVES	NO. OF PANS	CAP. CU. FT.	SHIP CU. FT.	SHIP WT. (LB/KG)
	L	D*	H**	L	D*	H**									
MBPT44	44 ³ / ₈	36 ¹ / ₂	42 ⁷ / ₈	1127	927	1089	115	6.5	3/8	1	2	(6) 1/3	9.7	43.2	309/140
MBPT67	67	36 ¹ / ₂	42 ⁷ / ₈	1702	927	1089	115	6.5	3/8	2	4	(9) 1/3	17.8	64.4	548/249
MBPT93	93 ¹ / ₄	36 ¹ / ₂	42 ⁷ / ₈	2369	927	1089	115	7.5	1/2	3	6	(12) 1/3	27.2	89.0	698/317

*Depth includes cutting board. **Height includes casters.

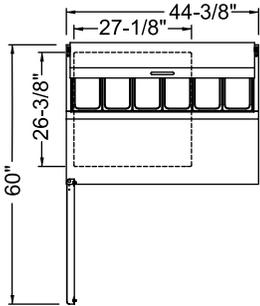

MBPT44 PLAN VIEW

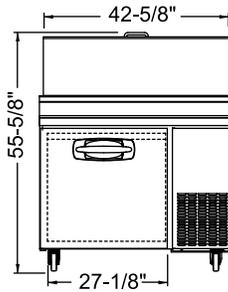

MBPT44 ELEVATION VIEW

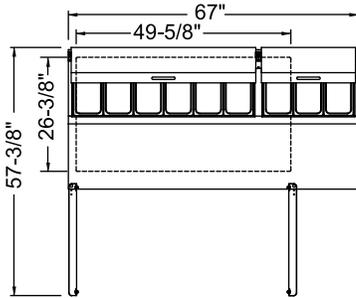

MBPT67 PLAN VIEW

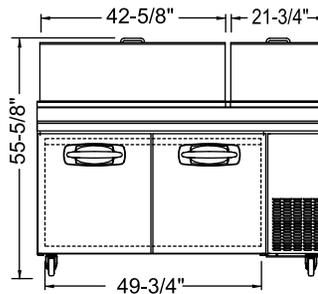

MBPT67 ELEVATION VIEW

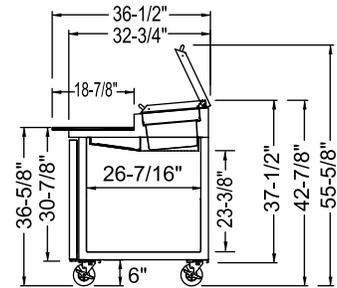

SIDE VIEW - ALL MODELS

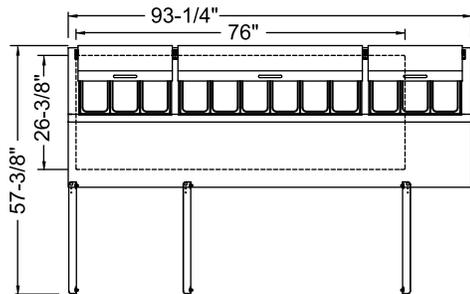

MBPT93 PLAN VIEW

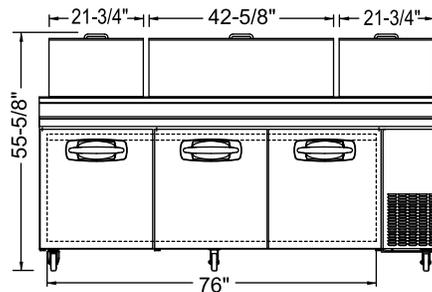

MBPT93 ELEVATION VIEW

HOOKUP

All models via plug in, 9 foot long flexible three wire 14/3 cord with molded plug.

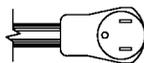

NEMA 5-15P

OPTIONAL REFRIGERATED DRAWER CONFIGURATIONS

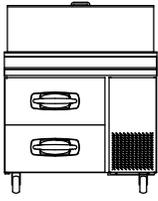

MBPT44-001

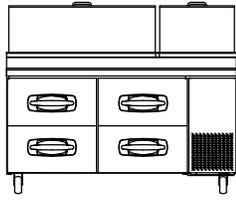

MBPT67-001

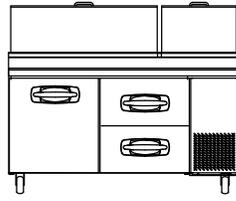

MBPT67-002

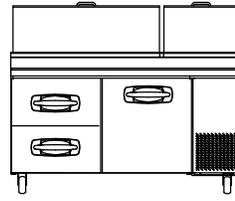

MBPT67-003

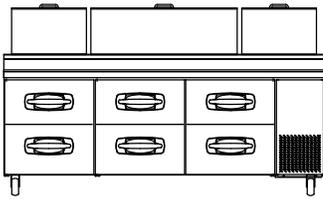

MBPT93-001

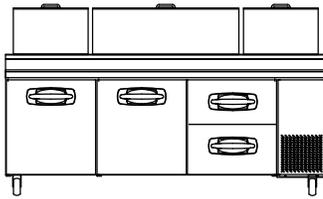

MBPT93-002

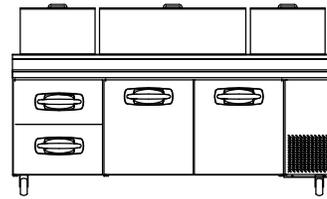

MBPT93-003

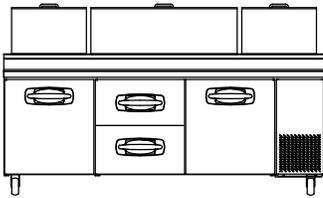

MBPT93-004

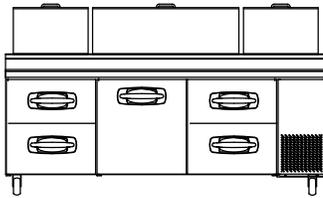

MBPT93-005

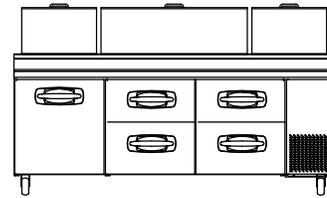

MBPT93-006

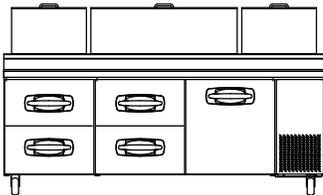

MBPT93-007

PAN CONFIGURATIONS FOR REFRIGERATED DRAWERS

MBPT44

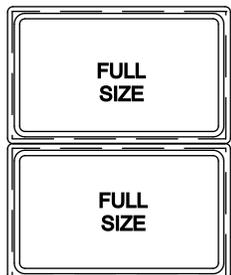

TOP & BOTTOM DRAWERS

DRAWER FRONT



MBPT67 & MBPT93

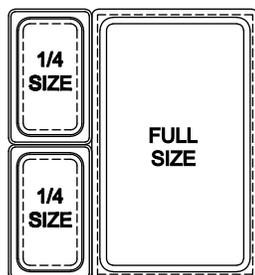

TOP & BOTTOM DRAWERS

DRAWER FRONT



*U.S. size pans, pans provided by others

Drawers accept up to 6-inch deep pans.

OPTIONAL OVERSHELF SPECIFICATIONS

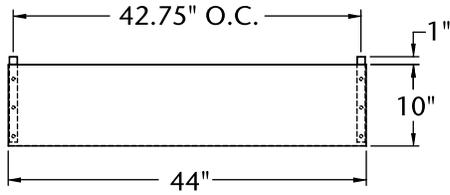

PLAN VIEW MBPT44

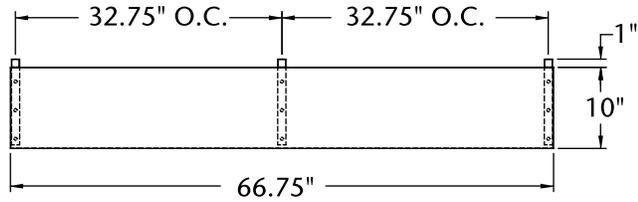

PLAN VIEW MBPT67

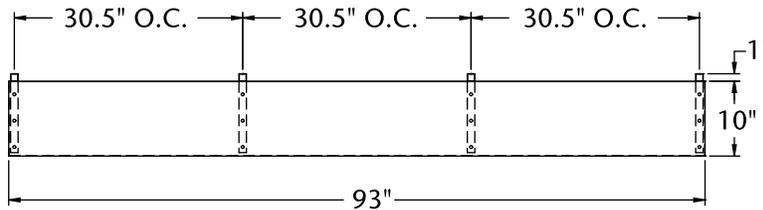

PLAN VIEW MBPT93

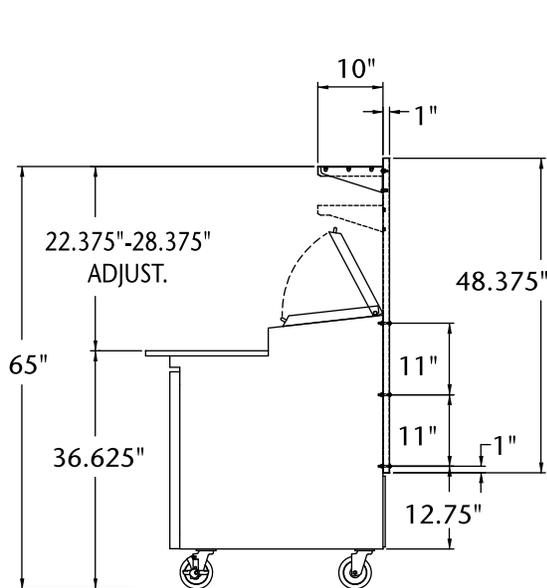

SINGLE SHELF SIDE VIEW

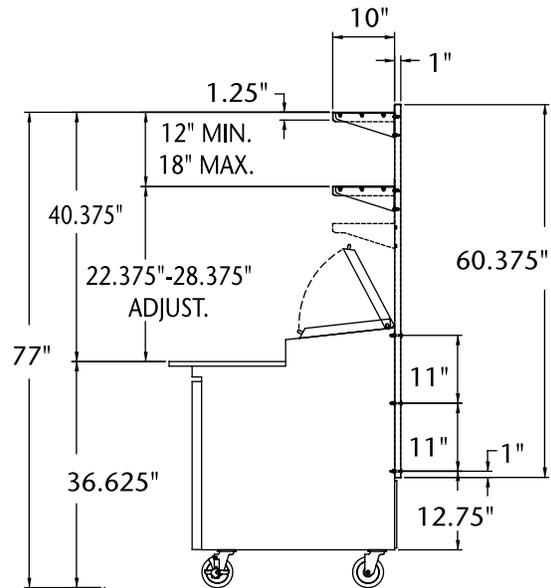

DOUBLE SHELF SIDE VIEW

NOTE: Cabinet designed for optimum performance in air-conditioned area at 75°F ambient and 55% relative humidity. All specifications subject to change without notice.