



MBUF/MBUR48



ENERGY STAR® qualification applies to undercounter refrigerator models only.

MBU SERIES

Undercounter/Worktable Refrigerators & Freezers

REFRIGERATORS

- MBUR27
- MBUR36
- MBUR48
- MBUR60
- MBUR72

FREEZERS

- MBUF27
- MBUF48
- MBUF60

FEATURES

CONSTRUCTION

- Curved corner design creates a stylish appearance and reduces chances of injury in slip-and-fall accidents
- Stainless steel interior and exterior
- Foamed-in-place with low ODP polyurethane insulation
- Wall thickness: 2"
- 6" diameter casters
- Adjustable heavy-duty vinyl-coated shelves

DOORS

- Self-closing
- Standard door swing configuration:
 - 1-door models hinged right
 - 2-door models.....left hinged left, right hinged right

- 3-door model.....left hinged left, middle door hinged left, right door hinged right
- Door width:
 - MBUR/MBUF27 27¹/₄"
 - MBUR36..... 18"
 - MBUR/MBUF48..... 23⁷/₈"
 - MBUR/MBUF60..... 30"
 - MBUR72..... 23⁷/₈"

REFRIGERATION

- Self-contained forced air refrigeration system
- Refrigerant:
 - MBUR models & MBUF27 ... R-134a
 - All other MBUF models.....R-404A
- Temperature range:
 - MBUR..... 32° to 40°F (0° to 4°C)
 - MBUF -1° to -11°F (-18° to -24°C)

WARRANTY

- **Standard limited three year parts and labor**
- **Additional two year coverage on compressor part**

OPTIONS

- Low profile casters for ADA compliance
- Single or double overshef
- Refrigerated drawers (excluding MBUR36)

BID SPECIFICATIONS

Item no. MBU_____. Provide _____ Undercounter/worktable refrigerator/freezer(s), Master-Bilt model no. MBU_____. Undercounter will feature rounded corner construction with stainless steel interior and exterior. The refrigeration system will be bottom

mounted and self-contained. Freezers will use R-404A refrigerant, except for MBUF27 which will use R-134a. Refrigerators will use R-134a. The temperature range will be 32° to 40°F (0° to 4° C) for refrigerators and -1° to -11°F (-18° to -24°C) for freezers. Undercounter to have standard limited

three year parts and labor with additional two year coverage on compressor part. Undercounter to be UL, C-UL and ETL Sanitation listed with ENERGY STAR qualification on undercounter refrigerator models.

TECHNICAL SPECIFICATIONS

MODEL	DIMENSIONS (in.)			DIMENSIONS (mm)			VOLTS	AMPS	UNIT H.P.	NO. OF DOORS	NO. OF SHELVES	CAP. CU. FT.	SHIP CU. FT.	SHIP WT. (LB/KG)
	L	D	H*	L	D	H*								
REFRIGERATORS														
MBUR27	27 ¹ / ₂	30	35 ⁷ / ₈	699	762	911	115	3.2	1/5	1	1	7.0	21.1	199/90
MBUR36	36 ³ / ₈	30	35 ⁷ / ₈	924	762	911	115	3.6	1/5	2	2	9.4	26.6	242/110
MBUR48	48 ¹ / ₄	30	35 ⁷ / ₈	1226	762	911	115	7.9	3/8	2	2	13.0	35.9	280/127
MBUR60	60 ³ / ₈	30	35 ⁷ / ₈	1534	762	911	115	7.9	3/8	2	2	16.5	44.2	333/151
MBUR72	72 ³ / ₈	30	35 ⁷ / ₈	1838	762	911	115	8.1	3/8	3	3	20.0	52.2	384/175
FREEZERS														
MBUF27	27 ¹ / ₂	30	35 ⁷ / ₈	699	762	911	115	8.3	3/8	1	1	7.0	21.1	207/94
MBUF48	48 ¹ / ₄	30	35 ⁷ / ₈	1226	762	911	115	8.9	1/2	2	2	13.0	35.9	298/135
MBUF60	60 ³ / ₈	30	35 ⁷ / ₈	1534	762	911	115	8.9	1/2	2	2	16.5	44.2	350/159

*Height includes casters.

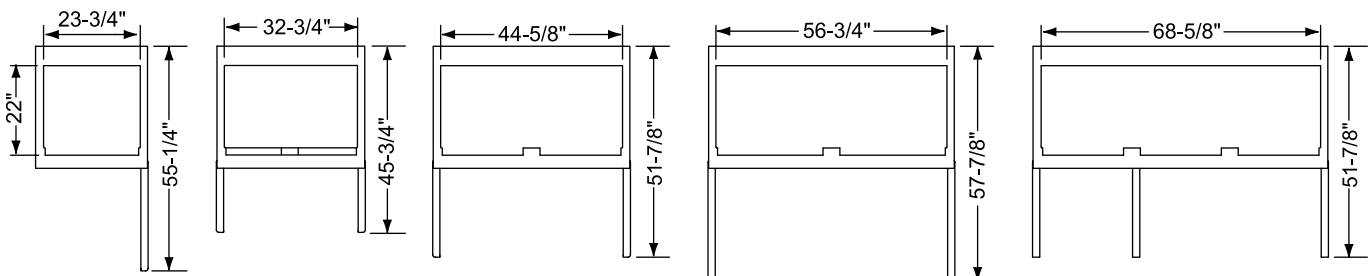

MBUR/MBUF27
PLAN VIEW

MBUR36
PLAN VIEW

MBUR/MBUF48
PLAN VIEW

MBUR/MBUF60
PLAN VIEW

MBUR72
PLAN VIEW

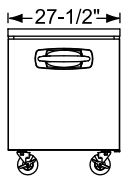

MBUR/MBUF27
ELEVATION
VIEW

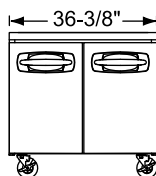

MBUR36
ELEVATION
VIEW

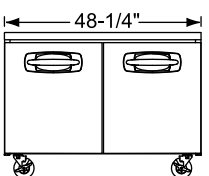

MBUR/MBUF48
ELEVATION
VIEW

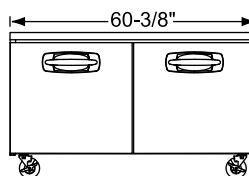

MBUR/MBUF60
ELEVATION
VIEW

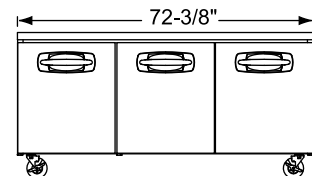

MBUR72
ELEVATION
VIEW

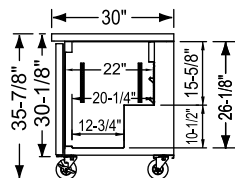

ALL MODELS
SIDE VIEW

LISTINGS



ENERGY STAR® qualification applies only to undercounter refrigerator models.

HOOKUP

All models via plug in, 9 foot long flexible three wire 14/3 cord with molded plug.



NEMA 5-15P

OPTIONAL REFRIGERATED DRAWER CONFIGURATIONS

MBUR models only, not available on MBUR36.

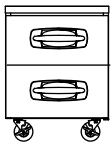

MBUR27-001

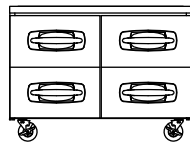

MBUR48-001

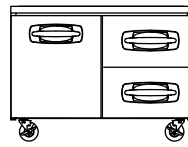

MBUR48-002

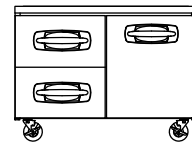

MBUR48-003

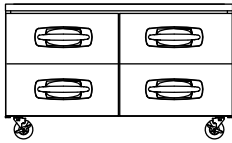

MBUR60-001

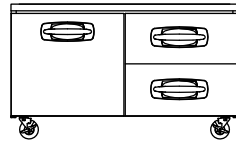

MBUR60-002

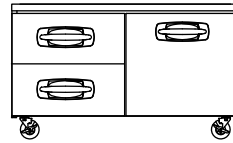

MBUR60-003

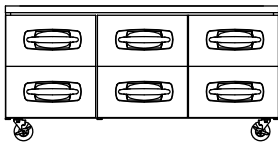

MBUR72-001

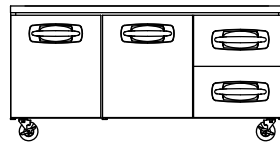

MBUR72-002

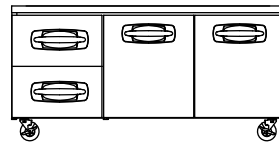

MBUR72-003

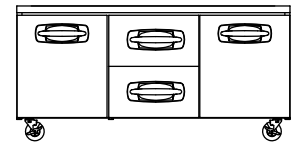

MBUR72-004

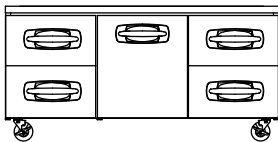

MBUR72-005

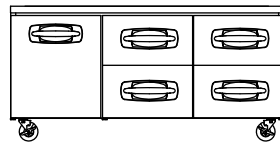

MBUR72-006

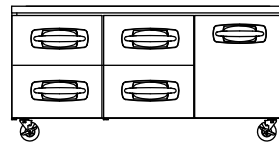

MBUR72-007

PAN CONFIGURATIONS FOR REFRIGERATED DRAWERS

MBUR models only, not available on MBUR36.

MBSP27, MBSMP27 & MBUR27

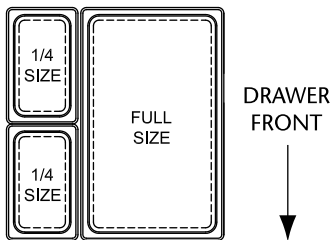

TOP DRAWER

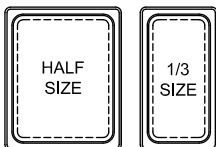

BOTTOM DRAWER

MBSP48, MBSMP48, MBUR48
& MBSP72, MBSMP72, MBUR72

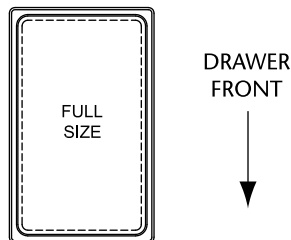

TOP DRAWER

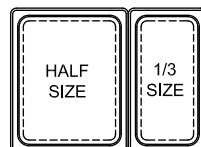

BOTTOM DRAWER

MBSP60, MBSMP60 & MBUR60

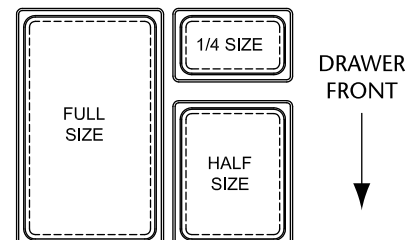

TOP DRAWER

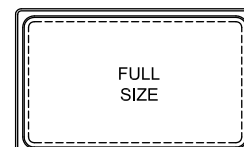

BOTTOM DRAWER

*U.S. size pans, pans provided by others. Drawers accept up to 6-inch deep pans.

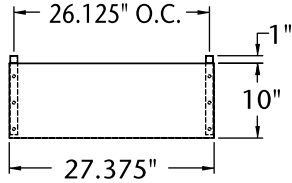

PLAN VIEW
MBSP27, MBSMP27,
MBUR/MBUF27

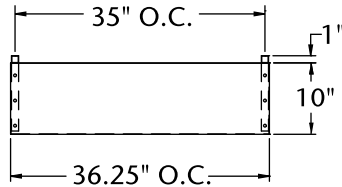

PLAN VIEW
MBSP36, MBSMP36,
MBUR36

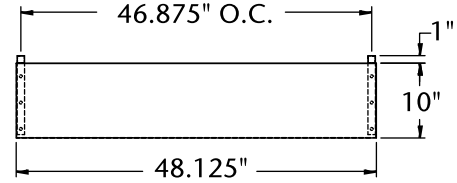

PLAN VIEW
MBSP48, MBSMP48,
MBUR/MBUF48

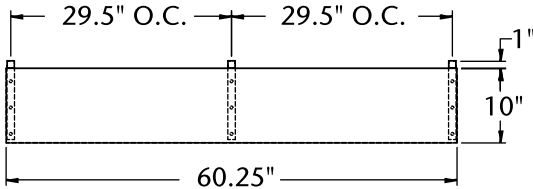

PLAN VIEW
MBSP60, MBSMP60, MBUR/MBUF60

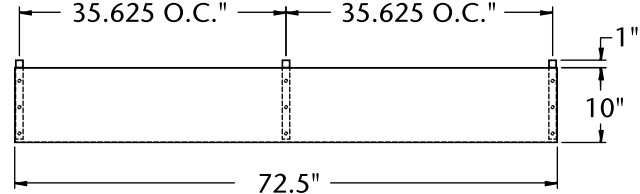

PLAN VIEW
MBSP72, MBSMP72, MBUR72

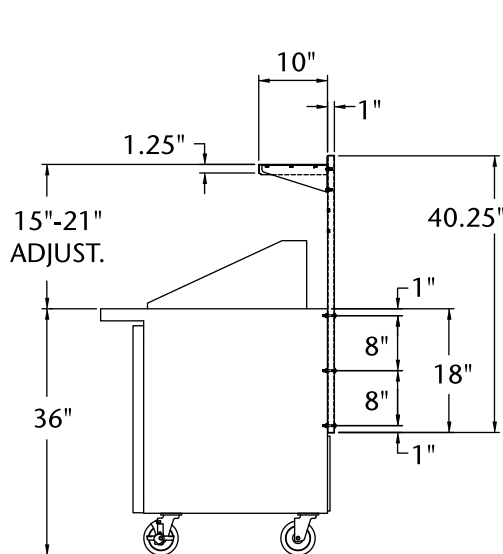

SINGLE SHELF SIDE VIEW

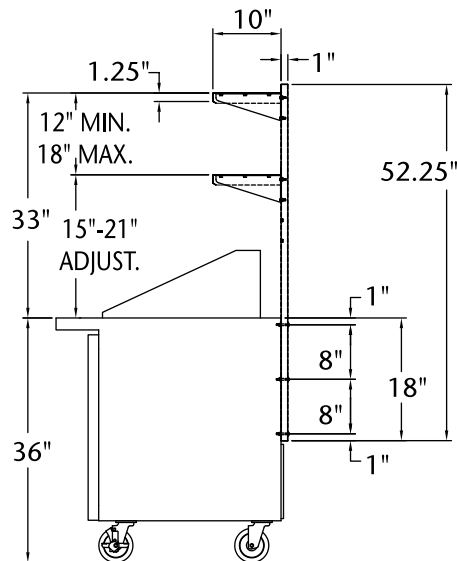

DOUBLE SHELF SIDE VIEW

NOTE: Cabinet designed for optimum performance in air-conditioned area at 75°F ambient and 55% relative humidity.
All specifications subject to change without notice.