

- Dramatic proportions highlight classic Italian style.
- The draft tower is a marketing tool, not just a bar fixture.
- Ceramic color complements the bar top.
- All stainless steel contact with the beer for the ultimate in draft purity.



Brass  
**CT900-4BRKR**





Chrome  
**CT900-4CHKR**

## Features

Faucet knobs not included.

 Certified by the National Sanitation Foundation.

 Stainless Steel beer contact for the pure taste of fresh draft beer.

 The integrated Kool-Rite module provides optimum cooling at the point of dispense. Modular construction makes the installation process as simple as PLUG "N" POUR.

# Specifications

Micro Matic reserves the right to change specifications without notice.

**AUTOQUOTES**

Part No.	Faucets	Finish	Dispense System	Shipping Weight	Box Dimensions
<input type="checkbox"/> <b>CT900-4CHKR*</b>	4	Chrome	Kool-Rite (Glycol)	12 kg 27 lbs	1016mm L x 622mm W x 533mm H 40"L x 24 1/2"W x 21"H
<input type="checkbox"/> <b>CT900-4BRKR*</b>	4	Brass	Kool-Rite (Glycol)	12 kg 27 lbs	1016mm L x 622mm W x 533mm H 40"L x 24 1/2"W x 21"H

 Certified

# Dimensions

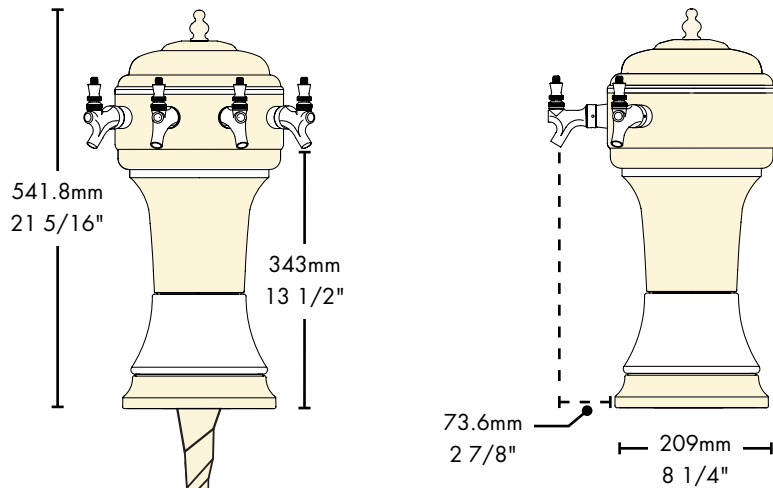

**BEER:**

6.4mm (1/4") O.D. Stainless Steel  
with 7.94mm - 9.52mm (5/16" - 3/8") Barb Fittings

**GLYCOL:**

9.52mm (3/8") O.D. Copper  
with 9.52mm (3/8") Barb Fittings

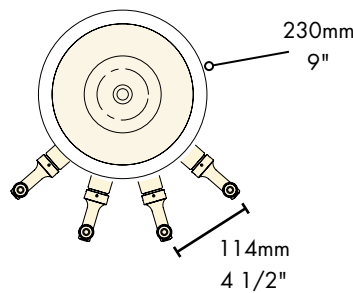
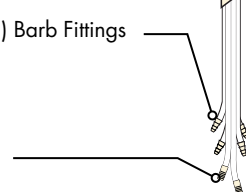

**Mounting Guide**

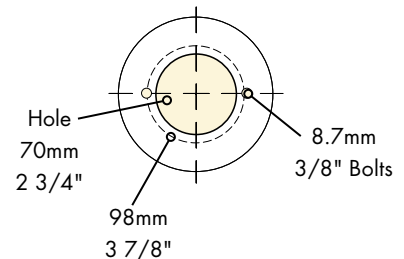

Copyright ©2011 Micro Matic USA, Inc. All Rights Reserved. 00228D1008



[www.micromatic.com](http://www.micromatic.com)

Toll Free: 1-(866) 327-4159

West	Central	Southeast	Northeast
19791 Bahama Street Northridge, CA 91324 Tel. (818) 701-9765 Fax. (818) 701-9844	10726 North Second Street Machesney Park, IL 61115 Tel. (815) 968-7557 Fax. (815) 968-0363	2364 Simon Court Brooksville, FL 34604 Tel. (352) 799-6331 Fax. (352) 796-2429	4601 Saucon Creek Road Center Valley, PA 18034 Tel. (610) 625-4464 Fax. (610) 625-4466