

- Display draft beer variety with contemporary style.
- The draft tower is a marketing tool, not just a bar fixture.
- Exterior finish will provide years of durable service.
- All stainless steel contact with the beer for the ultimate in draft purity.

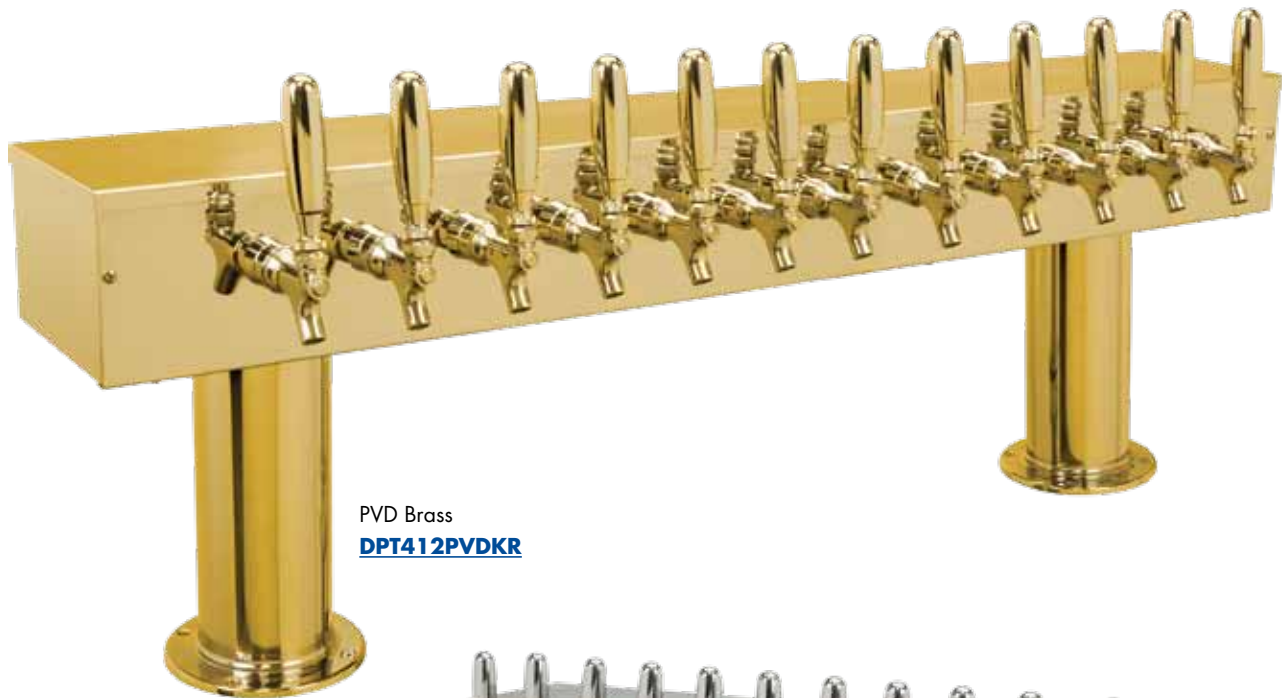

PVD Brass  
**DPT412PVDKR**





Stainless Steel  
**DPT412PSSKR**

Faucet knobs not included.

### Features

 Tarnish Free  
PVD Brass.

 Certified  
by the National  
Sanitation Foundation.

 Stainless Steel  
beer contact for the pure  
taste of fresh draft beer.

 The integrated Kool-Rite module provides  
optimum cooling at the point of dispense.  
Modular construction makes the installation  
process as simple as PLUG "N" POUR.

# Specifications

Micro Matic reserves the right to change specifications without notice.

**AUTOQUOTES**

Part No.	Faucets	Finish	Dispense System	Shipping Weight	Box Dimensions
<input type="checkbox"/> <a href="#">DPT412PSSKR*</a>	12	Polished S/S	Kool-Rite (Glycol)	26 kg 58 lbs	1168mm L x 940mm W x 406mm H 46"L x 37"W x 16"H
<input type="checkbox"/> <a href="#">DPT412PVDKR*</a>	12	PVD Brass	Kool-Rite (Glycol)	26 kg 58 lbs	1168mm L x 940mm W x 406mm H 46"L x 37"W x 16"H

\*  NSF Certified

# Dimensions

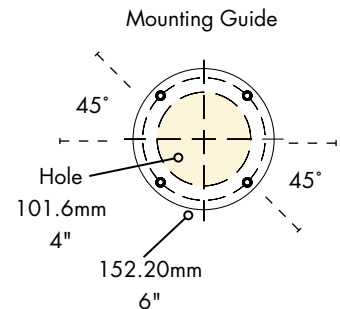
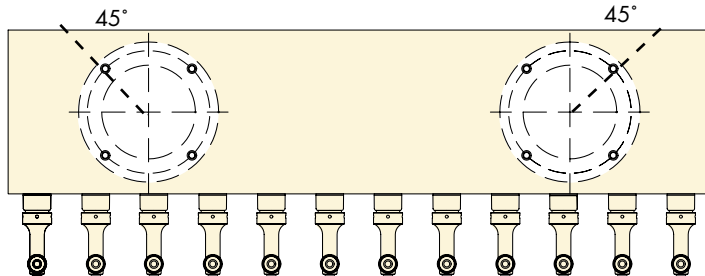
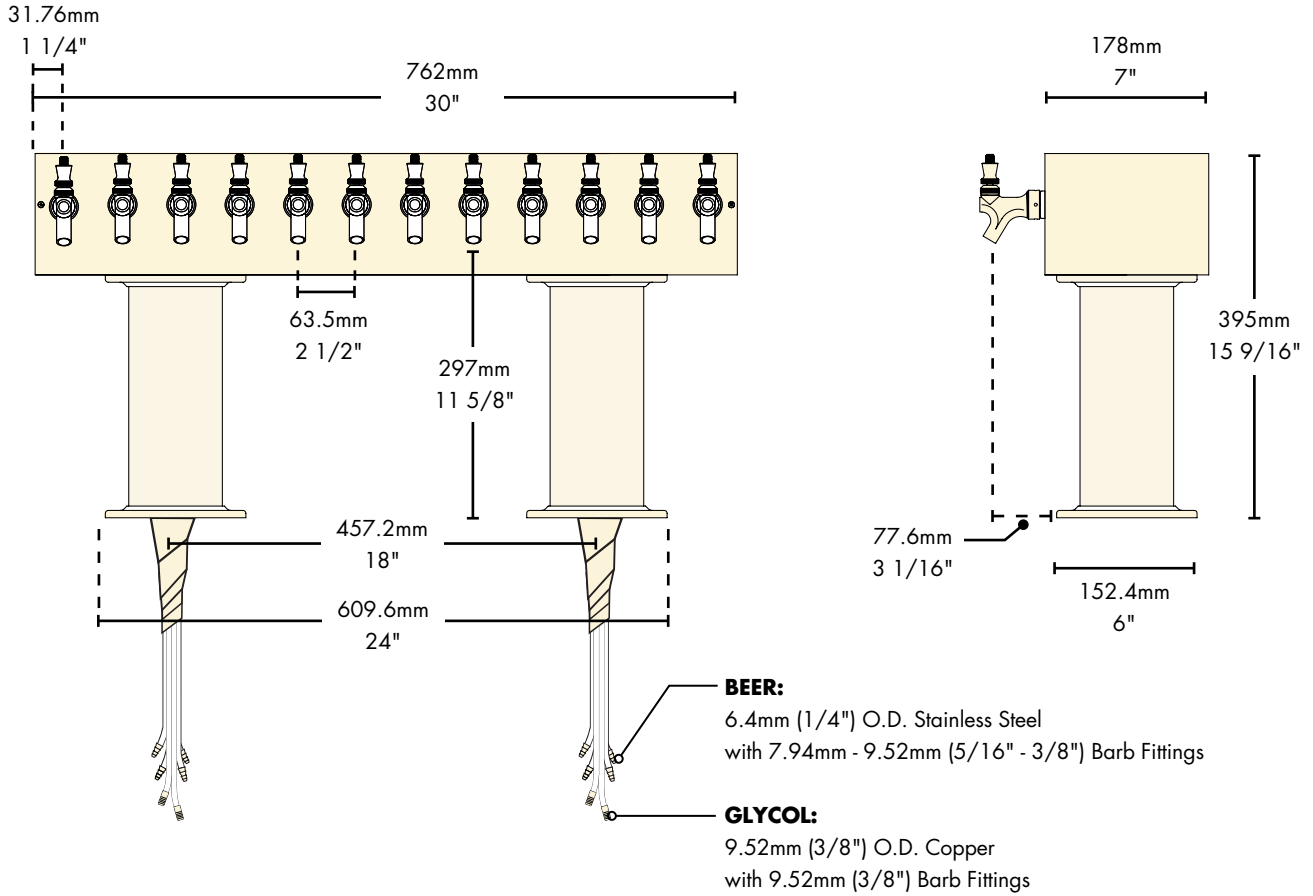

Copyright ©2012 Micro Matic USA, Inc. All Rights Reserved.

00214D0412



[www.micromatic.com](http://www.micromatic.com)

Toll Free: 1-(866) 327-4159

West	Central	Southeast	Northeast
19791 Bahama Street Northridge, CA 91324 Tel. (818) 701-9765 Fax. (818) 701-9844	10726 North Second Street Machesney Park, IL 61115 Tel. (815) 968-7557 Fax. (815) 968-0363	2364 Simon Court Brooksville, FL 34604 Tel. (352) 799-6331 Fax. (352) 796-2429	4601 Saucon Creek Road Center Valley, PA 18034 Tel. (610) 625-4464 Fax. (610) 625-4466