



LEGEND™ Heavy-Duty Gas Underfired Broilers — Radiant Style Shallow Depth Counter Models

Item No. _____

Project _____

Quantity _____



Model UFLCS-36R shown

UFLCS-R Series

MODEL GUIDE

✓ Model No.	Overall Width	Grates	Cooking Area
UFLCS-18R	18" (457mm)	2	12" x 24" (305 x 610mm)
UFLCS-24R	24" (610mm)	3	20" x 24" (508 x 610mm)
UFLCS-30R	30" (762mm)	4	26" x 24" (660 x 610mm)
UFLCS-36R	36" (914mm)	5	32" x 24" (812 x 610mm)
UFLCS-48R	48" (1219mm)	7	44" x 24" (1117 x 610mm)
UFLCS-60R	60" (1524mm)	9	56" x 24" (1422 x 610mm)
UFLCS-72R	72" (1829mm)	11	68" x 24" (1727 x 610mm)

SHORT/BID SPECIFICATIONS:

Broiler shall be a Montague **Legend** Heavy-Duty Model:

UFLCS- ____ R [Specify width]

...a shallow depth, low-profile countertop gas-fired unit with 19,000 BTU/hr stainless steel tubular burners with individual controls; heavy-duty stainless steel radiant heat deflectors (radiants), with a full width debris screen under burners; two-position, reversible cast iron ULTRA-FLOW top grates with both flat (wide) and narrow side with ribbed grease troughs; a full width front grease trough and large capacity grease container located in cool zone; 3-1/8" (79mm) front/plate rail, 1" (25mm) high rear flue riser and 4" (102mm) nickel finish legs standard; plus all the features listed and options/accessories checked:

BURNER/RADIANT SYSTEM FEATURES:

- 19,000 BTU/hr stainless steel tubular burners
- Individual manual gas valves for zoned heat control
- Standing pilot for automatic ignition
- Heavy-duty stainless steel radiants glow red for infrared broiling
- Removable self-cleaning radiants
- Full width debris screen under burners
- Full width removable drip tray.
- Radiants and drip tray heat shields reduce flare-ups

TOP-GRATE FEATURES:

- Reversible ULTRA-FLOW cast iron grate sections
- Ribbed side for narrow marking, with side grease troughs
- Flat side for broiling fish and wide marking
- 1" (25mm) ribbed grate spacing for consistent grilling results
- Two-position grid frame for flat or 3" (76mm) raised-rear grilling
- Sloped grates and side grate grease troughs to reduce flare-ups

STANDARD CONSTRUCTION FEATURES:

- Satin finish stainless steel front & top trim with 3-1/8" (79mm) deep front rail
- Other surfaces painted black with electrolytic zinc undercoating
- Full width front grease trough for easy transfer
- Removable large capacity grease container
- Stainless steel 1" (25mm) rear flue riser (matches height of range risers)
- 4" (102mm) adjustable nickel finish legs standard
- 3/4" NPT rear gas inlet with pressure regulator

AGENCY APPROVALS

- NSF Listed
- CSA Design Certified to ANSI Z83.11 • CSA 1.8
- CE Approved EN 203-1



HDB-2 [Rev. 1/15]

LEGEND™ Heavy-Duty Gas Underfired Broilers — Radiant Style Shallow Depth Counter Models

Item No. _____

Project _____

Quantity _____

UFLCS-R Series

Dimensions in brackets are millimeters

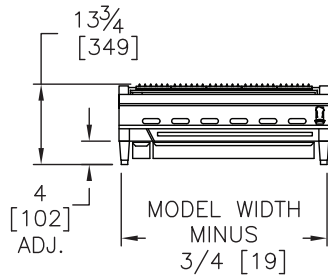

FRONT VIEW

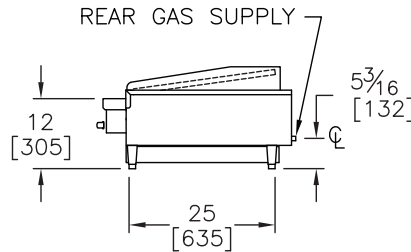

RIGHT SIDE VIEW

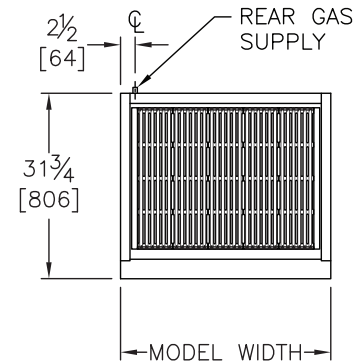

TOP VIEW

OPTIONS GUIDE:

General:

- Equipment Stand — 24" high x 30-5/8" deep (610 x 778mm), with stainless steel front, lower shelf & tubular legs with bullet feet
- Casters — set of four/six 5" (127mm) casters
- Flex Connector Kit [3/4" NPT:
 - 3' (914mm) long
 - 4' (1219mm) long
- UFLCS-18R - For battery installations only, Available with cabinet base

Grates & Splash Guards:

- Seafood grates, cast iron
- Round rod grates – 6" (152mm) sections:
 - Hard chrome
 - Cold rolled steel
- Scraper/cleaner for round rod grates
- Removable splash guard, stainless steel

Finish:

- Stainless steel left side panel
- Stainless steel right panel
- Stainless steel back panel

International Approvals:

- CE-Conformite Europeene
- Includes Flame Failure Valve Option*
- Canadian Approval

INSTALLATION REQUIREMENTS & SHIPPING INFORMATION

- Broilers must be installed in accordance with local codes or in their absence with the National Fuel Gas Code: ANSI Z223.1; Natural Fuel Gas Code: CAN/CGA-B149.1 or Propane Installation Code: CAN/CGA-B149.2, as applicable. Compliance with codes is the responsibility of the Owner and Installer.
- An adequate ventilation system is required. Refer to National Fire Protection Association Standard No. 96, "Standard for Ventilation and Fire Protection of Commercial Cooking Operations."
- This appliance is intended for commercial use by professionally trained personnel. NOT intended for Residential Use.
- Specify installation elevation: _____ if above 2000 feet (610m).
- GAS INLET SIZE (All Models): 3/4" NPT at left rear. A 3/4" NPT gas pressure regulator is provided and must be installed (by others) when unit is connected to gas supply.
- The incoming gas line pressure into the regulator should be 8"-14" w.c. for natural gas, and 12"-14" w.c. for propane gas.

Minimum Clearances	Noncombustible Construction
From Back Wall	0"
Left & Right Side	0"
For use in noncombustible locations only.	

Models:	Burners	Specify Type of Gas:		Shipping Weight	Shipping Class	Cube (Crated) ft ³ /m ³
		<input type="checkbox"/> Natural	<input type="checkbox"/> Propane			
Manifold Pressure:		6.0" WC	10.0" WC			
		BTU/hr (kW)	BTU/hr (kW)			
UFLCS-18R	2	38,000 (11.1)	38,000 (11.1)	160 lbs (74 kg)	85	13/.4
UFLCS-24R	4	76,000 (22.3)	76,000 (22.3)	220 lbs (100 kg)	85	13/.4
UFLCS-30R	5	95,000 (27.8)	95,000 (27.8)	265 lbs (120 kg)	85	20/.6
UFLCS-36R	6	114,000 (33.4)	114,000 (33.4)	305 lbs (138 kg)	85	20/.6
UFLCS-48R	8	152,000 (44.5)	152,000 (44.5)	400 lbs (181 kg)	85	26/.7
UFLCS-60R	11	209,000 (61.2)	209,000 (61.2)	495 lbs (224 kg)	85	35/1
UFLCS-72R	13	247,000 (72.4)	247,000 (72.4)	590 lbs (267 kg)	85	38/1.1



THE MONTAGUE COMPANY

1830 Stearman Avenue, Hayward, CA 94545

800 345-1830 • Fax: 510 785-3342

www.montaguecompany.com

Due to continuous product improvements, specifications are subject to change without notice.



HDB-2 [Rev. 1/15]