



ADVANTEDGE™ MEGA TOP SANDWICH FOOD PREP REFRIGERATORS



PROJECT:

 ITEM NUMBER:

 MODEL NUMBER:

MEGA TOP SANDWICH FOOD PREP REFRIGERATORS

SPECIFICATIONS FOR: NLSMP27-12, NLSMP36-15, NLSMP48-18, NLSMP60-24, NLSMP72-30

- **Finish:** Stainless steel interior and exterior.
- **Insulation:** Complete cabinet and doors are foamed-in-place with polyurethane insulation. Insulated pan cover.
- **Hardware:** Curved handle with recessed pocket and one epoxy coated shelf per door, 6" diameter casters standard.
- **Electrical:** 115 volt, 60 Hz, 1 phase with cord and plug.
- **Refrigeration:** Self contained forced air refrigeration system. The condensate is collected and automatically evaporated from an energy efficient hot gas style vaporizer. Refrigerant flow is controlled by a capillary tube. R-134a refrigerant. Temperature range: +32°F to +40°F.
- **Accessories:** 1/6 size pans and 9-1/2" polyethylene cutting board included.
- **Approvals:** UL, C-UL and ETL Sanitation listed **

STANDARD FEATURES

- 1/6 size pans included
 *Note: NLSMP27-12 has (9) 1/6 size pans and (3) 1/9 size pans included.
- Air cooled condensing unit
- Automatic condensate vaporizer
- Automatic defrost
- Capillary tube system
- Casters
- Cutting board
- Magnetic gaskets
- Self closing doors
- Stainless steel interior and exterior
- UL, C-UL and ETL Sanitation listed **
- Warranties: 3 year parts & labor, 5 year compressor

OPTIONAL FEATURES*

- Additional shelves
- Overshelf assemblies
- Pull out drawers



Nor-Lake, Inc.
 Registered to ISO 9001:2008
 File No. 10001816

* Most options are available two weeks from receipt of order. Please contact us for specific questions.
 ** C-UL is Underwriters Laboratories Safety Certification Mark which indicates that UL has tested the equipment to applicable CSA Standards.
 ** UL-Sanitation is Underwriters Laboratories Safety Certification Mark which indicates that UL has tested the equipment to applicable NSF Standards.

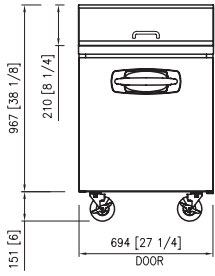

FRONT

NLSMP27-12

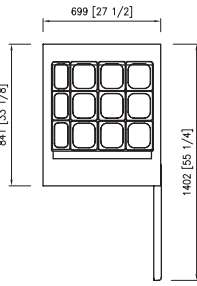

TOP

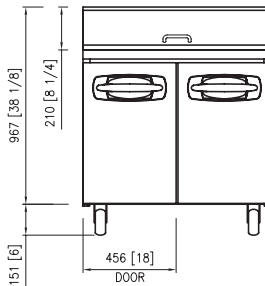

FRONT

NLSMP36-15

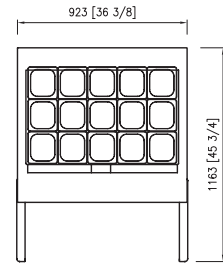

TOP

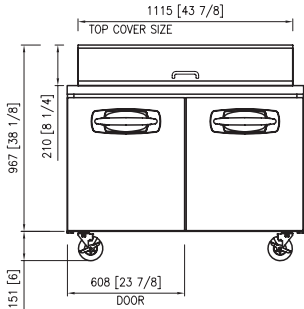

FRONT

NLSMP48-18

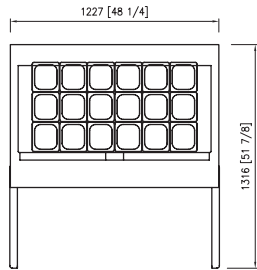

TOP

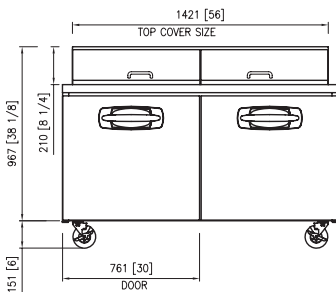

FRONT

NLSMP60-24

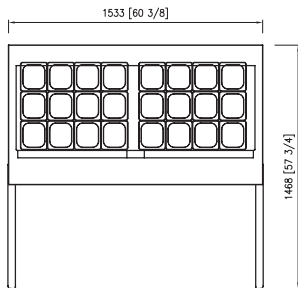

TOP

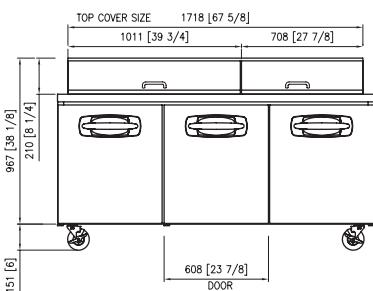

FRONT

NLSMP72-30

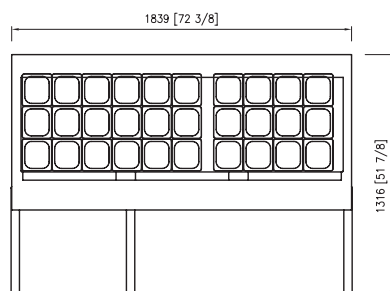

TOP

SPECIFICATIONS

Models	NLSMP27-12	NLSMP36-15	NLSMP48-18	NLSMP60-24	NLSMP72-30
Crated Height	44-1/2"	44-1/2"	44-1/2"	44-1/2"	44-1/2"
Crated Width	30-1/8"	37-1/4"	51-1/8"	63"	74-3/8"
Crated Depth	35-1/5"	35-3/8"	35-3/8"	35-3/8"	35-3/8"
Crated Weight (lbs.)	223	284	318	362	399
Interior Height	21-1/8"	26-1/8"	26-1/8"	26-1/8"	26-1/8"
Interior Width	23-3/4"	32-3/4"	44-5/8"	56-3/4"	68-5/8"
Interior Depth	20-1/4"	20-1/4"	20-1/4"	20-1/4"	20-1/4"
Overall Height	44-1/8"	44-1/8"	44-1/8"	44-1/8"	44-1/8"
Overall Width	27-1/2"	36-3/8"	48-1/4"	60-3/8"	72-3/8"
Overall Depth	35-1/4"	35-1/4"	35-1/4"	35-1/4"	35-1/4"
Gross Cubage (ft. ³)	7	10	13	16	20
Number of 1/6 Pans	12*	15	18	24	30
Number of Shelves	1	2	2	2	3
Number of Casters	4	4	4	4	4
Condensing Unit Size	1/5 HP	1/5 HP	3/8 HP	3/8 HP	3/8 HP
Refrigerant	R-134a	R-134a	R-134a	R-134a	R-134a
Electrical Characteristics	115/60/1	115/60/1	115/60/1	115/60/1	115/60/1
Cord and Plug Furnished	Yes	Yes	Yes	Yes	Yes
Nema Plug Configuration	5-15P	5-15P	5-15P	5-15P	5-15P
Total Amp Draw	3.2	3.4	7.9	7.9	9.9

Specifications subject to change without notice.



Revision Date: 03/13
 ©2013 Nor-Lake, Inc.
 Printed in the USA
 Part Number: 143381

