

3 H.P. Model 300



JOB:

Item No.:



FOOD WASTE DISPOSER SPECIFICATIONS

CORROSION RESISTANT BODY

Permanent molded from heat treated aluminum alloy.

TEFLON LIP WATER SEAL

Protects the motor from damage by water.

TAPERED ROLLER BEARING

Provides longer motor life, quiet operation and shock absorbing.

WATER COOLED MOTOR

Provides maximum efficiency and longer life.

QUIET OPERATION

Extra thick rubber mounting adaptor and drain outlet isolates sound and eliminates vibration.

WASTE MIXING CHAMBER

Extra large to ensure proper mixture of water to waste.

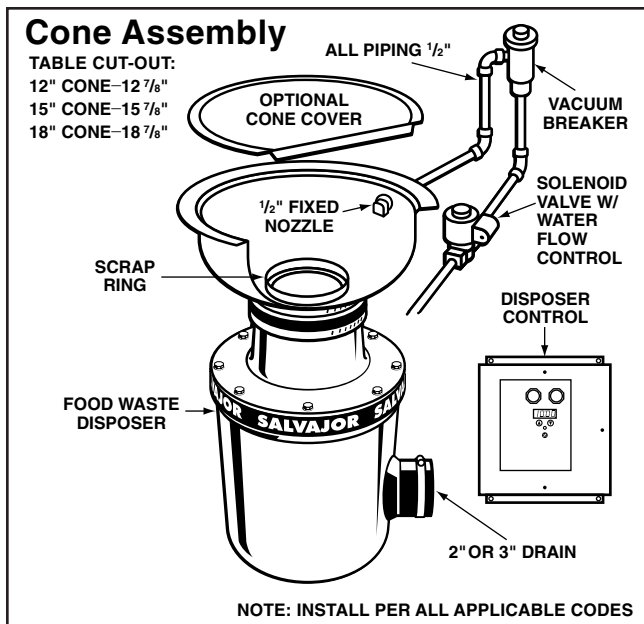

NEMA 4 Watertight Controls



MSS



MRSS



ARSS-2

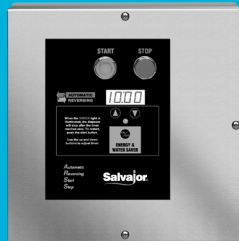

ARSS

Optional Line Disconnect (LD) available on MSS, MRSS, & ARSS

FULL LOAD AMPS

<input type="checkbox"/>	208 Volts	3 Phase	8.8 Amps
<input type="checkbox"/>	230 Volts	3 Phase	8.0 Amps
<input type="checkbox"/>	460 Volts	3 Phase	4.0 Amps

◆ SPECIFY EXACT OPERATING VOLTAGE ◆

Salvajor Model 300

Food Waste Disposer 3HP – 3 Phase

DETAILS AND DIMENSIONS

SPECIFICATIONS:

MOUNTING – Rubber adaptor above grind chamber and rubber drain outlet isolates sound and eliminates vibration. No metal to metal contact.

EXTERIOR HOUSING – Permanent molded from heat treated, corrosion resistant aluminum alloy then computer machined to a smooth polished finish. Paint free.

SHREDDER – 9 inch diameter, machined high strength, wear resistant hardened carbide alloy.

ROTOR – 9 inch diameter with 4 cutter bars, machined high strength, wear resistant hardened carbide alloy.

MOTOR – 3 HP totally enclosed. Fan cooled and water cooled for efficiency and longer life. Built-in manual reset thermal overload protection. Available in 208-230/460 volts, 60 cycle, 3 phase.

BEARINGS – Tapered roller (top)
Sealed ball (bottom)

SEAL – Teflon Lip Water Seal.

WATER REQUIREMENT – 8 gallons of cold water per minute.

WASTE OUTLET – Rubber drain accepts 2" piping or 3" piping by removing drain insert.

DUAL DIRECTION GRINDING – Designed to operate in either direction. Direction of rotation can be controlled when installed with automatic reversing controls. *Reversing rotation can double cutting teeth life.*

LEG SUPPORT – Single leg, adjustable.

ASSEMBLIES: (See Specification Sheet)

CA – Cone Assembly with 12", 15" or 18" Cone

SA – Sink Assembly with 3 1/2" or 6 1/2" Sink Collar

DISPOSER CONTROLS: (See Specification Sheet)

MSS: (Non Reversing)

MRSS: (Manual Reversing)

ARSS-2: (Automatic Reversing)

ARSS: (Automatic Reversing)

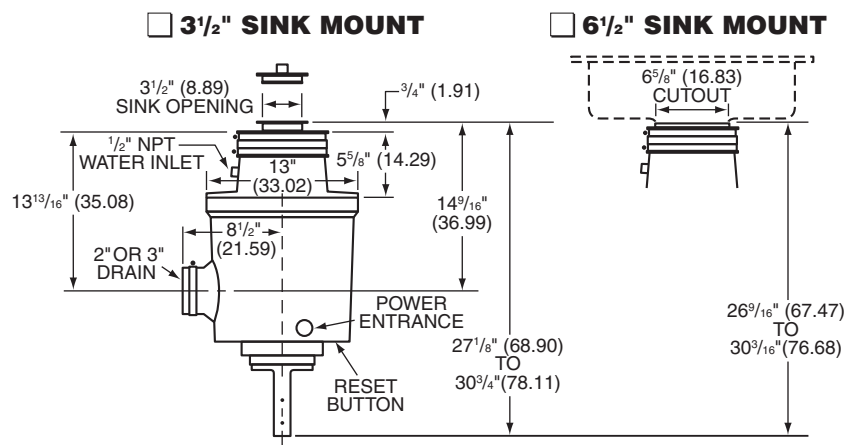
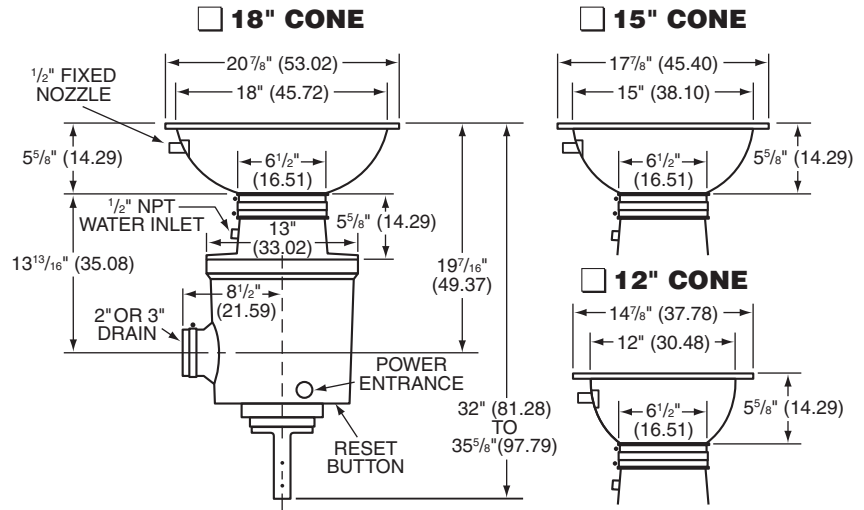

NOTE: Dimensions in parenthesis are in centimeters
(Specifications subject to change without notice)
Current specification details may be found online at www.salvajor.com

SAMPLE SPECIFICATION			
300-CA-18	ARSS	(230/60/3)	
Model	Cone Size	Disposer Control	Electrical Specs.
Assembly			
◆ SPECIFY EXACT OPERATING VOLTAGE ◆			



The Salvajor Company 4530 East 75th Terrace Kansas City, Missouri 64132-2081, USA

1-800-SALVAJOR

(816) 363-1030

FAX: 1-800-832-9373

www.salvajor.com

Email: sales@salvajor.com

service@salvajor.com

Manufacturers of Commercial Food Waste Disposing Systems since 1944