



Keyhole Bracket for easier installation and greater stability.



7-PS-40



7-PS-66



7-PS-76

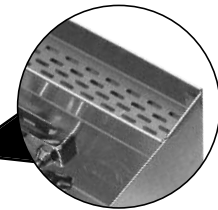

Includes Removable Rear Utility Tray



7-PS-87



7-PS-56

SPACE SAVER
9" x 9" x 5" Bowl

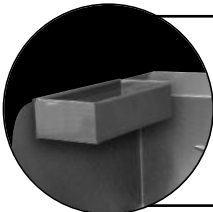

REMOVABLE UTILITY TRAY 7-PS-48

8" x 3" x 2 5/16" Tray.
Tray hem allows to hang from any standard side splash.
Perforated for water drainage.

STAINLESS STEEL
HAND SINKS
SIDE SPLASH UNITS



Item #: _____ **Qty #:** _____
Model #: _____
Project #: _____

STANDARD FEATURES:

One piece **Deep Drawn** sink bowl design.
Sink bowl is 10" x 14" x 5".
Keyhole wall mount bracket.
Stainless steel basket drain 1-1/2" IPS.
Splash mounted 4" O.C. gooseneck faucet furnished with aerator.

7-PS-40 & 7-PS-66 Specific Features:

7 3/4" high side splashes.
7-PS-40 lever operated drain and built-in overflow with plastic overflow tube and spring clamps. P-Trap is 1 1/2" IPS.

7-PS-56 Specific Features:

Space Saver Sink bowl is 9" x 9" x 5".
7 3/4" high side splashes.
Flat-Top Strainer 1-1/2" IPS.

7-PS-76 Specific Features:

12" high side splashes.
Includes 17 1/4" x 3" x 2 5/16" Full length removable Utility Tray for use with 12" Side Splash Units.
Lever operated drain and built-in overflow with plastic overflow tube and spring clamps. P-Trap is 1 1/2" IPS.

7-PS-87 Specific Features:

Same features as 7-PS-40 Plus C-Fold Paper Towel & Soap Dispenser.

CONSTRUCTION:

All TIG welded.
Welded areas blended to match adjacent surfaces and to a satin finish.
Die formed Countertop Edge with a 3/8" No-Drip offset.
One sheet of stainless steel - No Seams.
All sink bowls have a large liberal radii with a minimum dimension of 2" and are rectangular in design for increased capacity.

MATERIAL:

Heavy gauge type 304 series stainless steel.
Wall mounting bracket is galvanized and of offset design.
All fittings are brass / chrome plated unless otherwise indicated.

MECHANICAL:

Faucet supply is 1/2" IPS male thread hot and cold.

For Lead Free Compliant Faucet Upgrade, Add -CA to Appropriate Faucet (Example: k-59-CA)

For Replacement Faucets & Upgrades, Drains & Accessories visit our website at www.advancetabco.com



Customer Service Available To Assist You 1-800-645-3166 8:30 am - 8:00 pm E.S.T.

Email Orders To: customer@advancetabco.com. For Smart Fabrication™ Quotes, Email To: smartfab@advancetabco.com or Fax To: 631-586-2933

NEW YORK
Fax: (631) 242-6900

GEORGIA
Fax: (770) 775-5625

TEXAS
Fax: (972) 932-4795

NEVADA
Fax: (775) 972-1578

DIMENSIONS and SPECIFICATIONS

TOL Overall: ± .500" Interior: ± .250"

FITTINGS SUPPLIED AS SHOWN

ALL DIMENSIONS ARE TYPICAL

7-PS-40 & 7-PS-66 (7-PS-66 Excludes P-Trap & Lever Drain & Overflow)

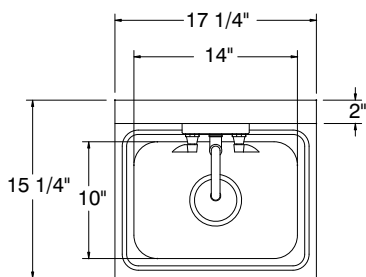

TOP VIEW FOR
7-PS-40 & 7-PS-66

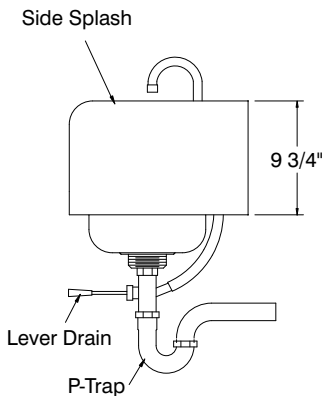
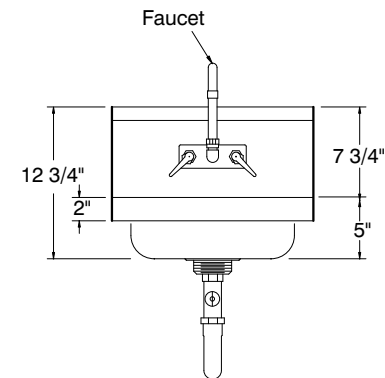

7-PS-40 - 22 lbs.
7-PS-66 - 19 lbs.

7-PS-56

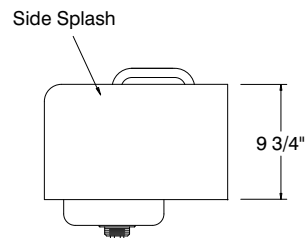
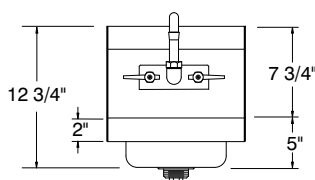
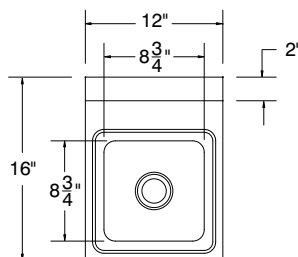

14 lbs.

7-PS-76

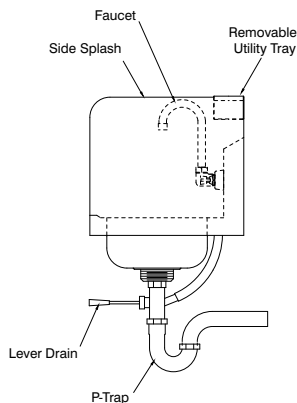
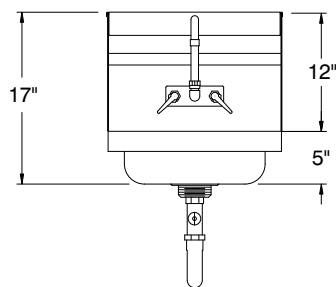
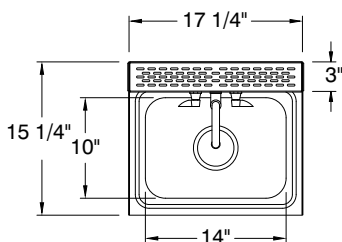

27 lbs.

7-PS-87

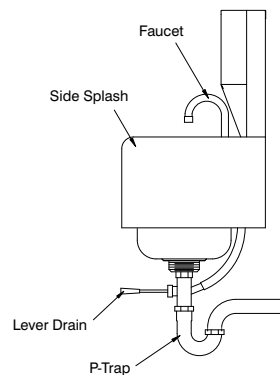
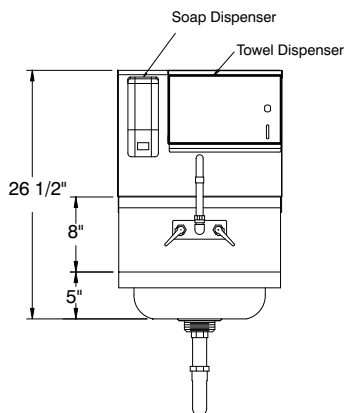
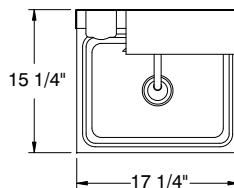

34 lbs.

