

SANDWICH UNIT REFRIGERATOR

Model: SW60-8C-FB-D

60" Cutting Top Sandwich Unit Refrigerator with Drawers - 8 Pans Front Breathing

Stainless steel front and top, aluminum end panels, case back and interior.
Certified under NSF-7 to maintain temperatures in 86°F ambient and designed to maintain NSF-7 temperatures in 100°F ambient.



Options and Accessories

(upcharge and lead times may apply)

Stainless steel exterior and interior - SS models	Solid doors in lieu of drawers
Stainless steel end panels - SA models	Expansion valve system
Glass doors in lieu of drawers - GD models	Rear-mounted cutting board
Stainless steel finished back in lieu of aluminum	Flat insulated night cover
Overshelves (single or double)	Remote models
Automatic, electric condensate evaporator	Drawer locks
Three tier drawers	

Consult factory for other model configurations, options and accessories.

Project Name:

Model Specified:

Location:

Item No:

Quantity:

AIA #:

SIS #:

Standard Model Features

REFRIGERATION SYSTEM

- Performance-rated refrigeration system
- Environmentally-safe R-134a refrigerant
- Unique air flow distribution allows pan product to maintain 33° - 41°F
- Automatic, energy saving, non-electric condensate evaporator
- Non-corrosive, plasticized fin evaporator coil
- Easily serviceable, back mounted compressor

CABINET ARCHITECTURE

- 2" non-CFC polyurethane foam insulation
- Magnetic snap-in drawer gaskets
- 19" deep, full length nylon cutting board
- Stainless steel roll-out drawers
- Insulated lid
- 3 5/8" casters
- Completely enclosed, vented and removable case back

MODEL FEATURES

- (8) 1/6 size non-recessed pans, 4" deep
- Interior hanging thermometer

Front breathers are a unique, field assembled, bottom mounted ventilation system designed to allow cabinets to be flush against a wall or built into a counter to conserve space.

Continental
 Refrigerator

Toll-Free: 800-523-7138
 Phone: 215-244-1400
 Fax: 215-244-9579

539 Dunksferry Road
 Bensalem, PA 19020
www.continentalrefrigerator.com

APPROVAL:

Model Specifications

DIMENSIONAL DATA

Net Capacity (cu. ft.)	17.0 (481 cu l)
1/6 Size Pans (4" deep)	8
Width, Overall (in.)	60 (1524 mm)
Depth, Overall (in.) (incl. cutting board & bumpers)	38 1/4 (972 mm)
Depth, Body Only (less drawers) (in.)	27 1/2 (699 mm)
Depth, Cutting Board (in.)	19 (483 mm)
Height, Overall (in.) (incl. 3 5/8" casters)	40 7/8 (1038 mm)
No. of Drawers (two tier)	4
No. of Drawers (three tier)	6

REFRIGERANT DATA

Condensing Unit Size (H.P.)	1/4
Capacity (BTU/Hr)*	1940

ELECTRICAL DATA

Voltage (int'l)	115/60/1 (220/50/1)
Fans	3
Total Amps (int'l)	6.6 (4.4)
10 ft. Cord/Plug [attached] (int'l)	Yes (No)

SHIPPING DATA

Weight (lbs.)	315 (143 kg)
Height - Crated (in.)	43 1/4 (1099 mm)
Width - Crated (in.)	68 1/4 (1734 mm)
Depth - Crated (in.)	46 (1168 mm)

DRAWER PAN CONFIGURATIONS

Two Tier: (1) 12 x 20 x 6 pan per drawer

Three Tier: (1) 12 x 20 x 4 pan per drawer

* Rating @ +25°F evaporator, 90°F ambient

Figures in parentheses reflect metric equivalents rounded to the nearest whole unit.



Equipped with one NEMA-5-15P Plug
(varies by country)

Continental

Refrigerator

Toll-Free: 800-523-7138
Phone: 215-244-1400
Fax: 215-244-9579

539 Dunkserry Road
Bensalem, PA 19020
www.continentalrefrigerator.com

Due to our continued efforts in developing innovative products, specifications subject to change without notice.



© Copyright 2013. Continental Refrigerator.
A Division of National Refrigeration & Air Conditioning Products, Inc.

Model Plan Views

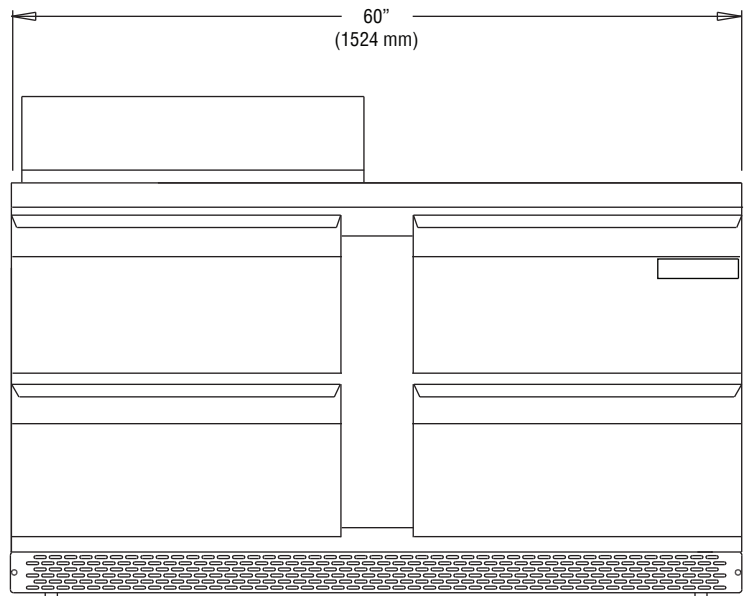

FRONT VIEW

Note: Shown with two tier drawers.

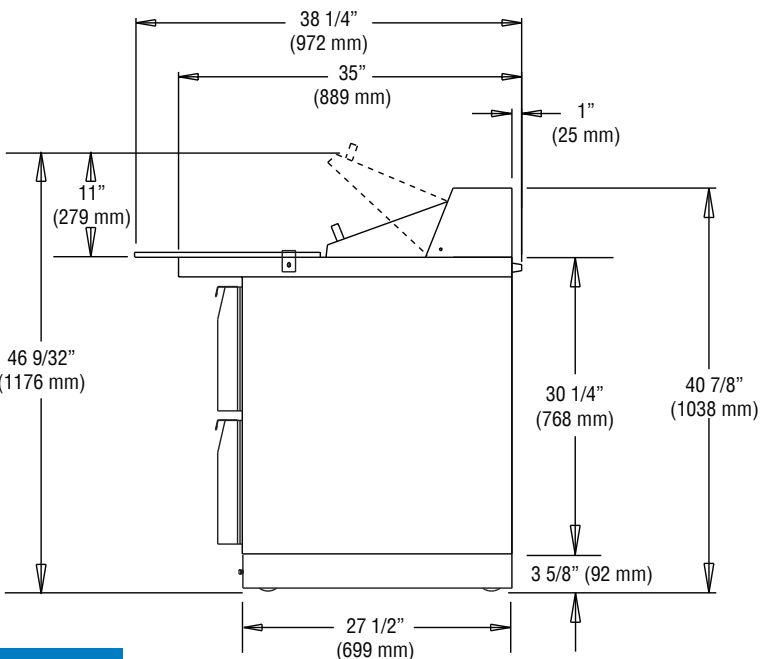

SIDE VIEW

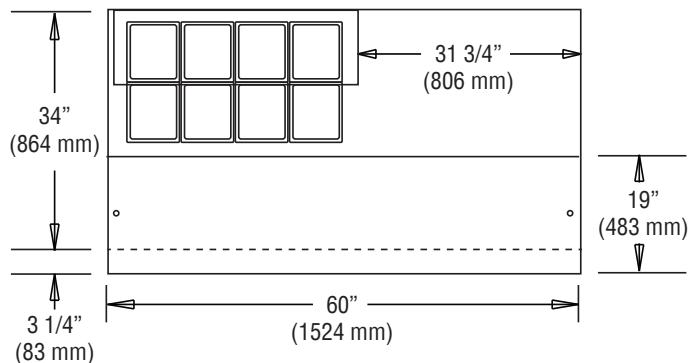

PAN TOP CONFIGURATION