



# COOKING EQUIPMENT

CENTER OF ALL YOUR FOOD SERVICE NEEDS

## PYRALIS SERIES PIZZA OVEN- SINGLE AND DOUBLE CHAMBERS WITH MECHANICAL CONTROL

Item #: 40637/ 40638/ 40641

Model#: PE-IT-0024-S/ PE-IT-0048-D/ PE-IT-0049-D

WITH  
ACTIVESTONE  
TECHNOLOGY

Pyralis ovens have a steel front, pre-painted white grey body, steel door with glass, a knob for opening and closing the steam exhauster and non-thermal handles.



ACTIVESTONE



Authorized Dealer

# COOKING EQUIPMENT

PYRALIS SERIES PIZZA OVEN- SINGLE CHAMBER AND MECHANICAL DISPLAY FEATURING ACTIVE STONE



## Features:

The Pyralis is an electric oven that was designed and built to offer extremely high levels of performance, efficiency and reliability with low operating costs. It is available for baking 4 to 18 pizzas with a diameter of 34 cm. In the mechanical version, the temperature is set by the top and bottom thermostats and is displayed on the mechanical thermometer. The Mechanical Pyralis has a safety thermostat and independent chambers. The door is balanced thanks to a spring with an adjustable tie-rod. The baking chambers are in stainless steel and illuminated by light kits with heat resistant lamps.

\* *Special Order are available for the following upon request: stainless stands, casters, hoods, vents and suction motor.*



### 23.7 cu. ft. Pyralis Series Oven with Single Chamber and Mechanical Display featuring Active Stone

ITEM NUMBER	40637
MODEL	PE-IT-0024-S
MAXIMUM TEMPERATURE	842° F / 450° C
ELECTRICAL	220V / 60 /3
POWER	6.6 kW
CHAMBER DIMENSIONS (LxDxH)	27.6" x 27.6" x 5.9"
EXTERNAL DIMENSIONS (LxDxH)	43" x 39.8" x 16.9"
PACKAGING DIMENSIONS (LxDxH)	43.3" x 44" x 21.6"
VOLUME	23.7 Cu. Ft.
WEIGHT	Net Weight: 115 kg / 253 lbs. Gross Weight: 132 kg / 291 lbs.

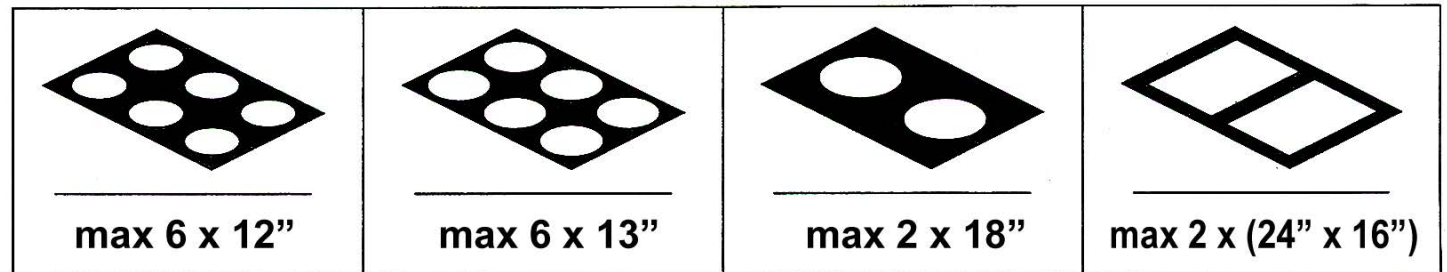
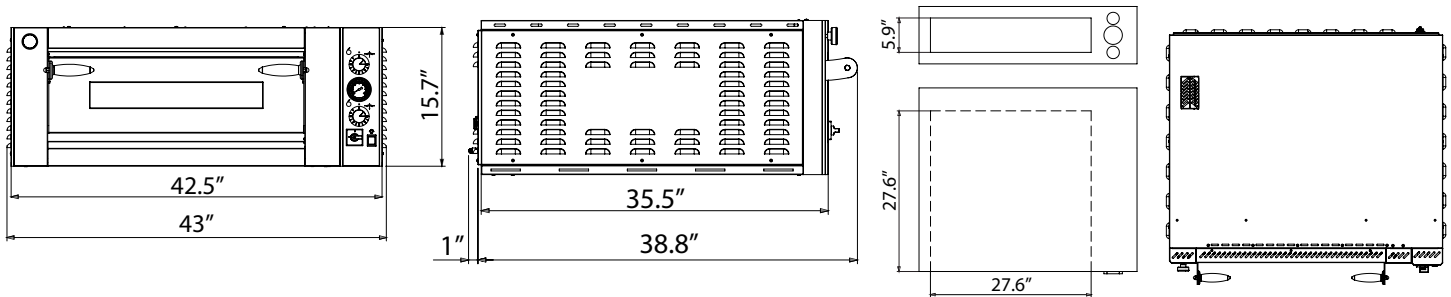

## OMCAN INC.

Telephone: 1-800-465-0234

Fax: (905) 607-0234

E-mail: [sales@omcan.com](mailto:sales@omcan.com)

Website: [www.omcan.com](http://www.omcan.com)



Follow us to keep up to date with the latest news and offers





# COOKING EQUIPMENT

PYRALIS SERIES PIZZA OVEN- DOUBLE CHAMBER AND MECHANICAL DISPLAY FEATURING ACTIVE STONE



40638

## 36.7 cu. ft. Pyralis Series Oven with Double Chamber and Mechanical Display featuring Active Stone

ITEM NUMBER	40638
MODEL	PE-IT-0048-D
MAXIMUM TEMPERATURE	842° F / 450° C
ELECTRICAL POWER	220V / 60 / 3 13.2 kW
CHAMBER DIMENSIONS (LxDxH)	(27.6" x 27.6" x 5.9") x 2
EXTERNAL DIMENSIONS (LxDxH)	43" x 39.8" x 29.5"
PACKAGING DIMENSIONS (LxDxH)	43.3" x 44" x 33"
VOLUME	36.7 Cu. Ft.
WEIGHT	Net Weight: 183 kg / 403.4 lbs. Gross Weight: 201 kg/ 443 lbs.



Mechanical display

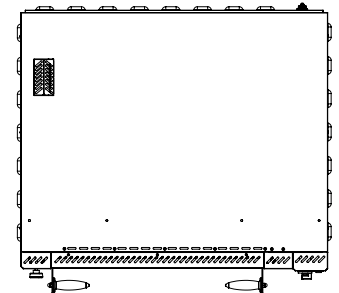
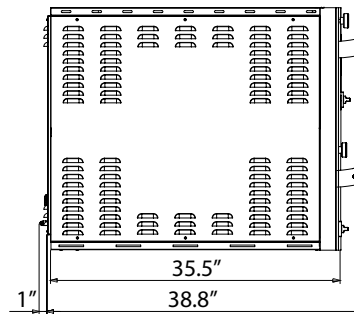
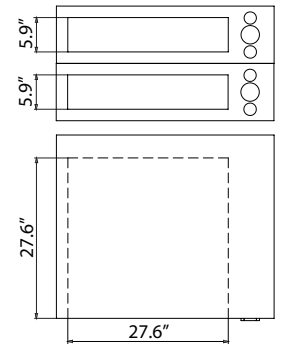
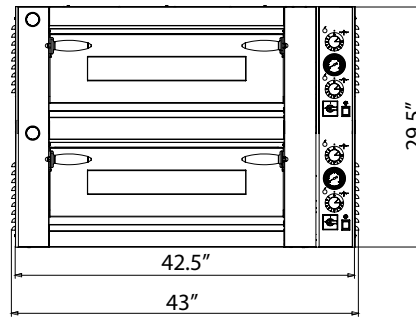

max 6 x 12"	max 6 x 13"	max 2 x 18"	max 2 x (24" x 16")

### OMCAN INC.

Telephone: 1-800-465-0234  
 Fax: (905) 607-0234  
 E-mail: sales@omcan.com  
 Website: www.omcan.com



Follow us to keep up to date with the latest news and offers



# COOKING EQUIPMENT

PYRALIS SERIES PIZZA OVEN- DOUBLE CHAMBER AND MECHANICAL DISPLAY FEATURING ACTIVE STONE



## 48.7 cu. ft. Pyralis Series Oven with Double Chamber and Mechanical Display featuring Active Stone

ITEM NUMBER	40641
MODEL	PE-IT-0049-D
MAXIMUM TEMPERATURE	842° F / 450° C
ELECTRICAL	220V / 60 / 3
POWER	18 kW
CHAMBER DIMENSIONS (LxDxH)	(41.3" x 27.6 x 5.9") x 2
EXTERNAL DIMENSIONS (LxDxH)	56.9" x 39.8" x 29.5"
PACKAGING DIMENSIONS (LxDxH)	44.1" x 57.9" x 33.1"
VOLUME	48.7 Cu. Ft.
WEIGHT	Net Weight: 231 kg / 509 lbs. Gross Weight: 254 kg / 560 lbs.

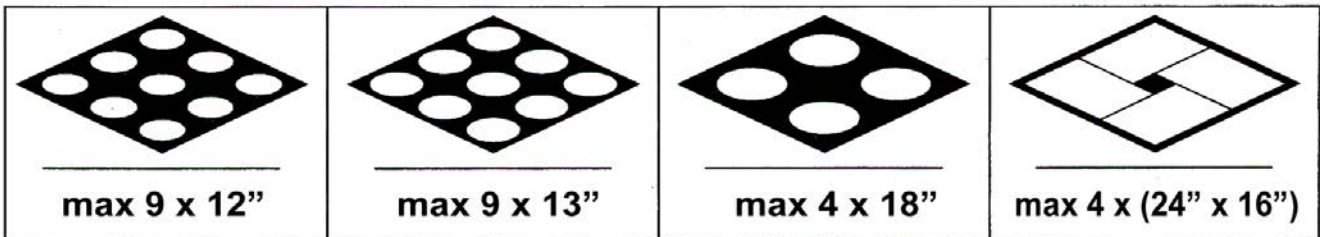
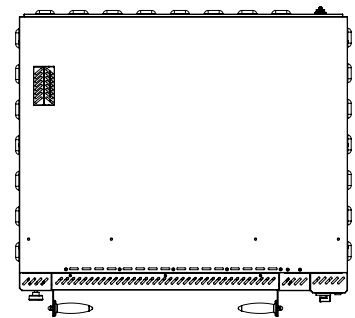
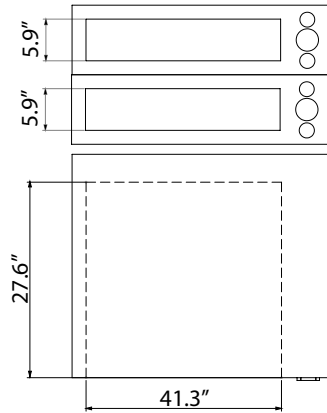
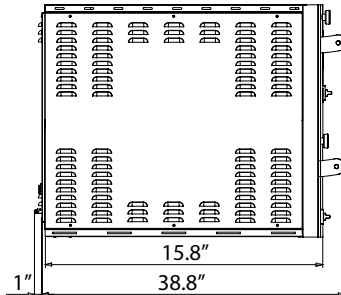
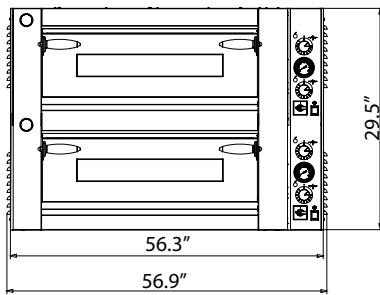

### The Activestone

Therographic test show that in a chamber heated by Activestone, the desired temperature can be reached within a shorter time span and heat is distributed evenly.

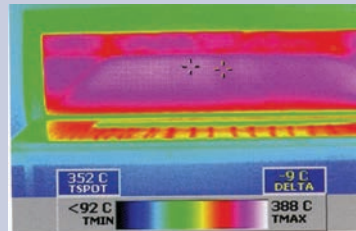
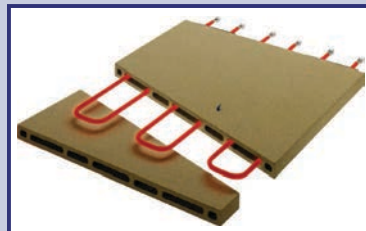

## OMCAN INC.

Telephone: 1-800-465-0234  
 Fax: (905) 607-0234  
 E-mail: sales@omcan.com  
 Website: www.omcan.com



Follow us to keep up to date with the latest news and offers

