



CHEESE MELTERS

CHEESE MELTERS



JCM-48

DESCRIPTION:

Cheese Melter to be Model # JCM-_____ manufactured by Jade®. To have high power infrared burner(s). Each burner to be furnished with one stainless steel pilot and gas tubing throughout. To be of 14 gauge all welded construction with stainless steel front, both sides and bottom. Each to be furnished with one stainless steel pilot and gas tubing throughout. Provide heavy gauge wall mount bracket. Unit to be provided with a 3/4" gas regulator.

SPECIFY TYPE OF GAS WHEN ORDERING.
SPECIFY ALTITUDE WHEN ABOVE 2,000 FT.

MODEL NO.	DESCRIPTION
<input type="checkbox"/> JCM-24	24" WIDE CHEESE MELTER
<input type="checkbox"/> JCM-36	36" WIDE CHEESE MELTER
<input type="checkbox"/> JCM-48	48" WIDE CHEESE MELTER
<input type="checkbox"/> JCM-60	60" WIDE CHEESE MELTER
<input type="checkbox"/> JCM-72	72" WIDE CHEESE MELTER
<input type="checkbox"/> JCM-84	84" WIDE CHEESE MELTER
<input type="checkbox"/> JCM-96	96" WIDE CHEESE MELTER
<input type="checkbox"/> JCM-108	108" WIDE CHEESE MELTER
<input type="checkbox"/> JCM-120	120" WIDE CHEESE MELTER
<input type="checkbox"/> JCM-144	144" WIDE CHEESE MELTER
<input type="checkbox"/> PASS-THRU	ADD "PT" TO END OF MODEL NUMBER
<input type="checkbox"/> EXTRA SHELF	ADD "+1" TO END OF MODEL NUMBER (ADDS 4-5/8" TO HEIGHT)
<input type="checkbox"/> RANGE MOUNT	ADD "RM" TO END OF MODEL NUMBER

Note: When range mounting on Titan™ equipment a riser must be ordered also.

STANDARD FEATURES

- Stainless steel front, sides, top and bottom
- High power infrared burners
- Stainless steel top
- 2" thick insulated bottom shelf
- 14 gauge all welded construction
- Stainless steel gas tubing throughout
- One stainless steel pilot tip per burner
- Heavy gauge wall mount bracket
- 3/4" gas regulator (shipped loose, MUST be installed for proper operation.)

OPTIONS & ACCESSORIES

- Stainless steel outer back panel for range mount unit
- Interconnect gas line (for single gas connection when mounting cheese melter on range)
- Stainless steel interior

WWW.JADERANGE.COM

JADE RANGE, LLC., A MIDDLEBY COMPANY • 2650 Orbiter Street • Brea, CA 92821 • PHONE: 800-884-5233 FAX: 714-961-2550
 Note: In line with their policy to continually improve products, Jade reserves the right to change materials and specifications without notice. PRINTED IN USA





CHEESE MELTERS

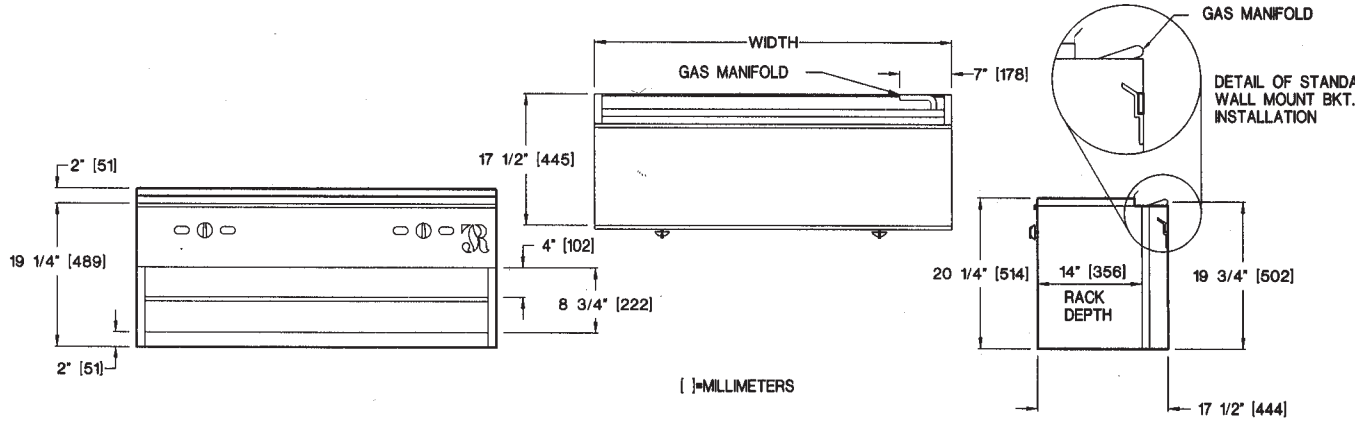

MODEL	BURNERS	BTUS	WIDTH	DEPTH	HEIGHT	APPX. SHP. WT.	APPX. CUBE
JCM-24	1	20,000	24"	17-1/2"	21-1/4"	105 LBS.	14
JCM-36	1	30,000	36"	17-1/2"	21-1/4"	160 LBS.	20
JCM-48	2	40,000	48"	17-1/2"	21-1/4"	210 LBS.	25
JCM-60	2	50,000	60"	17-1/2"	21-1/4"	260 LBS.	32
JCM-72	3	60,000	72"	17-1/2"	21-1/4"	320 LBS.	38
JCM-84	3	70,000	84"	17-1/2"	21-1/4"	380 LBS.	43
JCM-96	4	80,000	96"	17-1/2"	21-1/4"	440 LBS.	49
JCM-108	4	90,000	108"	17-1/2"	21-1/4"	500 LBS.	54
JCM-120	5	100,000	120"	17-1/2"	21-1/4"	560 LBS.	60
JCM-144	6	120,000	144"	17-1/2"	21-1/4"	600 LBS.	71

Note: For +1 model only, add 4-5/8" to height for additional shelf

NOTE: SPECIFY TYPE OF GAS WHEN ORDERING.

UTILITY INFORMATION:

- 3/4" Connection (see drawing for location)
- Required operating pressure:
 - Natural Gas 5" W.C. minimum
 - Propane Gas 10" W.C. minimum
 - 14" W.C. maximum

Note: The gas regulator **MUST** be installed for proper operation. This unit must be connected with the gas appliance regulator supplied.