

Sunkist Sectionizer

For safely preparing
fresh-cut wedges,
slices and halves



**Color-Coded
Blade Cups/Plungers**



- Quick & easy cleanup – dishwasher safe parts
- Uniform pieces for appealing presentation
- Listed by NSF International
- Interchangeable blade cups – 9 different ones

**Available from your
foodservice equipment dealer**

Contact us for the one nearest you:

800.383.7141 • fax 909.822.2125

Foodservice Equipment Sales, Sunkist Growers

10509 Business Dr., Unit B, Fontana, CA 92337

foodservice.sunkist.com/equipment

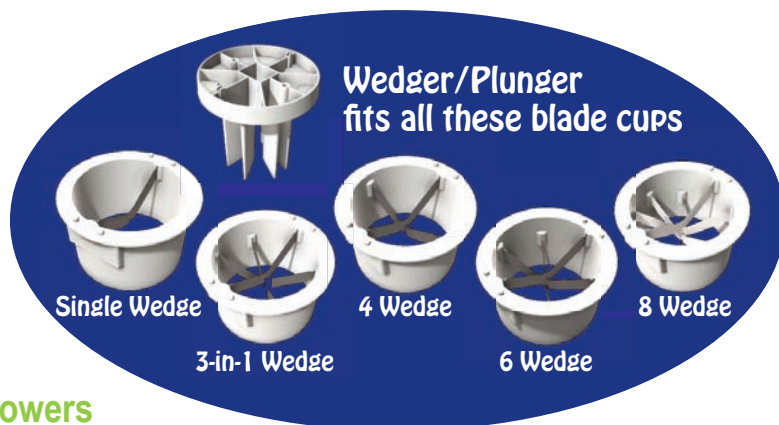

Sunkist







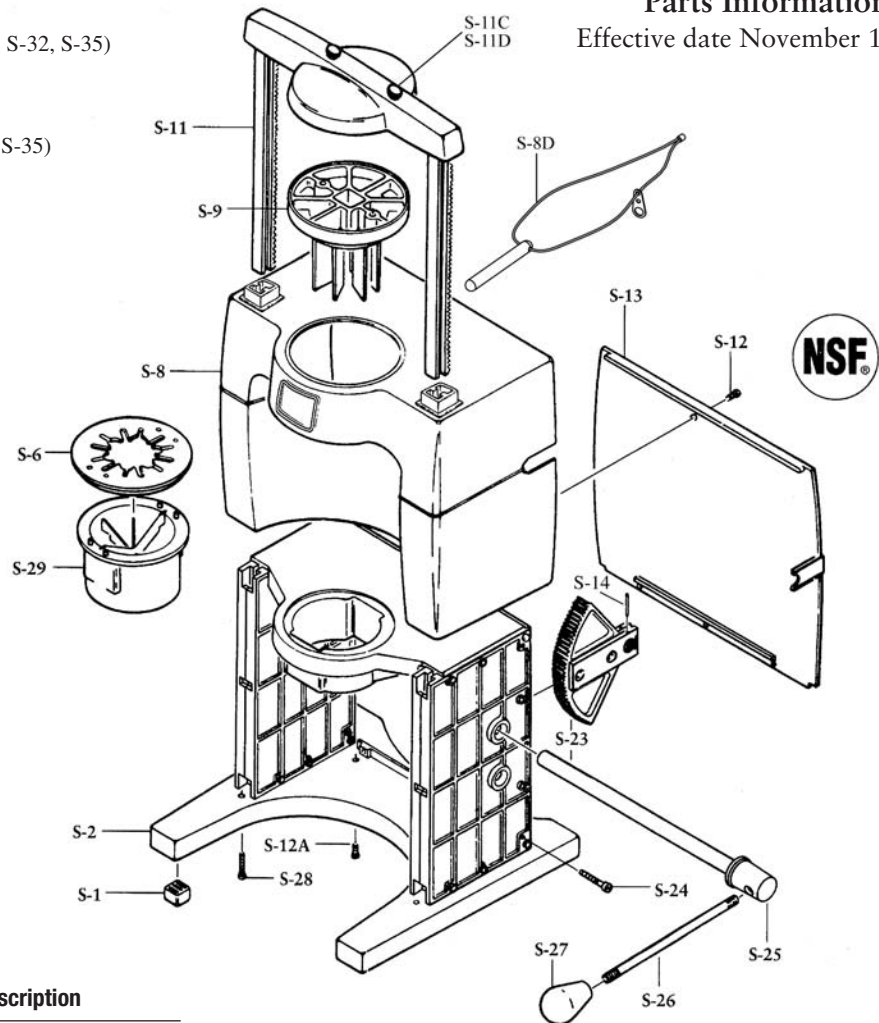

Sectionizer

Parts Information

Effective date November 1, 2011

Part Number	Parts Description
S-1	Foot Pad (set of 6)
S-2	Base Assembly
S-3B	Blade Cup w/cover (6 wedge) (fits S-9)
S-4B	Blade Cup w/cover (6 slice) (fits S-10)
S-5B	Blade Cup w/cover (4 wedge) (fits S-9)
S-6	Wedge Cup cover (sold w/S-3, S-5, S-29, S-30, S-32, S-35)
S-7	Slicer Cup cover (sold w/S-4)
S-8	Outer Shell
S-8D	Pin & Thread Assembly
S-9	Plunger Wedger (fits parts S-3, S-5, S-29, S-30, S-35)
S-10	Plunger Slicer (fits S-4)
S-11	Crossbar Assembly
S-11C	Brass Knob
S-11D	Brass Stud
S-12	Back Screw #8 x 1/2" (set of 8)
S-13	Back Cover
S-14	Spring Pin (set of 2)
S-15	7 Slice Blade Cup w/cover (fits S-16)
S-16	Plunger Tomato Slicer (fits part S-15)
S-17	Tomato Set (S-15 & S-16)
S-19	Wedge Cup Cover (10 wedge) (sold w/S-20)
S-20B	Blade Cup w/cover (10 wedge) (fits S-21)
S-21	Plunger (fits S-20)
S-22	10 Wedge Set (S-20 & S-21)
S-23	Gears & Shaft Set
S-24	Base Side Screw 6-32 x 1 1/2" (set of 10)
S-25	Plastic Shaft Cover
S-26	Handle
S-27	Knob
S-28	Bottom Screw #8 x 1 1/2" (set of 4)
S-29B	Blade Cup w/cover (8 wedge) (fits S-9)
S-30B	Blade Cup w/cover (3-in-1) (fits S-9)
S-31	Plastic Production Stand (see below)
S-32B	Apple Corer Cup (fits S-33)
S-33	Apple Plunger (fits S-32)
S-34	Apple Corer Set (S-32 & S-33)
S-35B	Blade Cup w/cover (single) (fits S-9)



Complete Sectionizer Model #	Blade Cup Style	Description
S-101		4 evenly spaced and cut wedges.
S-102		6 evenly spaced and cut wedges.
S-103		6 slices 5/16" thick. Must use plunger S-10.
S-104		8 evenly spaced and cut wedges.
S-105		2 halves scored in 3 wedges each (for school foodservice).
S-106		6 evenly spaced and cut wedges with center core removed. Must use plunger #33.
S-107		Cuts fruit & vegetables in half.
S-109		7 evenly spaced slices. Must use plunger S-16.
S-110		10 evenly spaced and cut wedges.

Specifications

Safe...Listed by NSF International®.

Overall Dimensions15 1/2" high, 15 1/4" wide, 13 3/8" deep

Net Weight13 pounds

Shipping Weight15 pounds

Cube2.32

Carton Size17 1/2" L x 13 1/2" W x 17 1/2" H

Plastic Production Stand (Optional)

Part Number S-31



A sturdy plastic stand that allows serving pans (not included) to pass under the sectionizer for greater production flexibility.

Overall Dimensions5 3/4" high, 14 1/2" wide

Shipping Weight2 pounds, 3 oz.