

Project

Quantity

Item #

Model Specified:

CSI Section 11400

### Compact Sandwich Prep Tables with Raised Cover/Self-Contained R290

### 27", 32, 48", 60" & 72" Wide Models



Model UPT4812LR-0300



Stainless Exterior,  
Anodized Aluminum  
Interior

- 27" Wide 6 Pan R290 Model
- 27" Wide 9 Pan R290 Model
- 32" Wide 8 Pan R290 Model
- 32" Wide 12 Pan R290 Model
- 48" Wide 8 Pan R290 Model
- 48" Wide 12 Pan R290 Model
- 48" Wide 18 Pan R290 Model
- 60" Wide 12 Pan R290 Model
- 60" Wide 24 Pan R290 Model
- 72" Wide 12 Pan R290 Model
- 72" Wide 18 Pan R290 Model
- 72" Wide 24 Pan R290 Model
- 72" Wide 30 Pan R290 Model

Traulsen shares your commitment to Corporate Sustainability initiatives and knows that it is more than just meeting the current and future regulatory requirements set by the EPA and DOE. We are committed to reducing global warming potential (GWP) and saving energy consumption while maintaining the performance and quality you have come to expect from Traulsen products.

Traulsen is proud to offer the North American market a broad selection of self-contained reach in and compact undercounter refrigeration with R290, a natural recurring refrigerant with a GWP of (3), the lowest currently available in our industry.

### Standard Product Features

- High Quality Stainless Steel Exterior Top, Sides & Door(s)
- Durable, Corrosion Resistant Anodized Aluminum Interior
- Provides NSF Standard 7 Performance, Even When Using 6" Deep Pans - A Traulsen Exclusive
- Front Breathing Self-Contained Refrigeration System
- Standard Work Height 36-1/4" (see "optional accessory kits for lower height casters to meet ADA requirements or provide lower work heights)
- Environmentally Friendly R290 Refrigerant
- Top Cut-Outs Accommodate Sixth Size Pans (divider bars and 4" deep plastic sixth size pans provided)
- Reinforced Pan Ledge (holds pans securely level)
- Removable Stainless Steel Insulated Pan Cover & Pivoting Front Lid
- Reversible, Full Length White Nylon Cutting Board
- Self-Closing Stainless Steel Doors With Convenient Stay Open Feature @ 105 Degrees
- Metal Door Handles
- Anodized Aluminum Interior Door Liners
- Interior Mounted Thermometer
- Two (2) Powder Coated Steel Shelves Per Door, Mounted On Adjustable Pilasters
- Automatic Non-Electric Condensate Evaporator
- Magnetic Snap-In EZ-Clean Door Gasket(s)
- 8' Cord & Plug Attached
- Set of Four (4) 4" Casters (6 for 60" & 72" models)
- Three Year Parts And Labor Warranty
- Five Year Compressor Warranty

### Optional Accessory Kits\*

- CASTER 5SET4 (four 6" high casters for 27", 32" & 48" models)
  - CASTER 5SET6 (six 6" high casters for 60" & 72" models)
  - CASTER SET3IN (four 3-1/2" high casters for 27", 32" & 48" models)
  - CASTER SET4 (six 3-1/2" high casters for 60" & 72" models)
  - CASTER SET2IN (four 2-1/2" high casters for 27" models)
  - SHELF CPW1 (additional shelf for all 27" models)
  - SHELF CPW2 (additional shelf for all 32" models)
  - SHELF48 UPPER (upper shelf for all 48" models)
  - SHELF48 LOWER (lower shelf for all 48" models)
  - SHELF60 UPPER (upper shelf for all 60" models)
  - SHELF60 LOWER (lower shelf for all 60" models)
  - SHELF72 UPPER (upper shelf for all 72" models)
  - SHELF72 LOWER (lower shelf for all 72" models)
- \*All optional accessory kits are shipped separately for field installation.

### Factory Installed Options

- Stainless Steel Finished Back
- Other Door Hinges



This unit is listed to UL 471, CSA 120 and NSF 7 by an approved NRTL. Consult the factory or unit data plate for approval information.



### Sustainability Features

- SNAP compliant R290 (GWP 3) Refrigerant EPA Rule 20
- All Metal Construction And Long Equipment Life Reduces Pressure On Landfills
- Real World Energy Efficiency Helps Reduce Fossil Fuel Emissions

Approval: \_\_\_\_\_



TRAULSEN  
4401 BLUE MOUND RD.  
PHONE 1 (800) 825-8220  
Website: www.traulsen.com

FT. WORTH, TX 76106  
FAX-MKTG. 1 (817) 624-4302

Project	Quantity	Item #
Model Specified:		CSI Section 11400

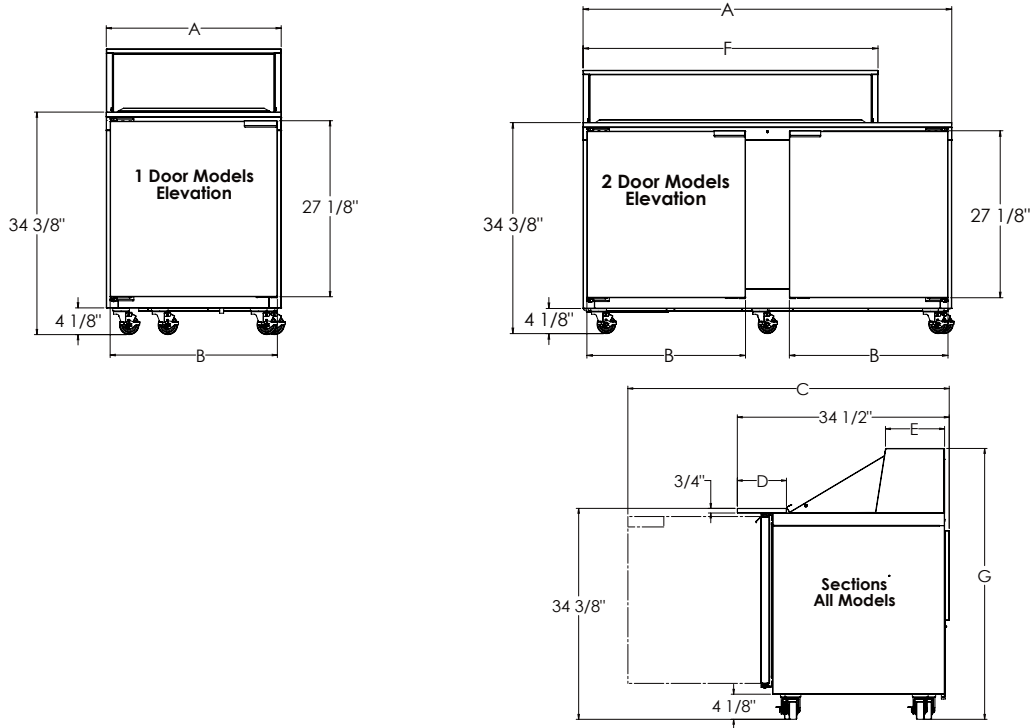

Cabinet Dimensional Data													
Model	Storage cu. ft.	# of 1/6 Size Pans Top	Width - cabinet	Width - door	Depth - door open 90°	Depth-Cutting Board	Depth-Lid Top	Width-Pan Cover Lid	Height-Overall (mounted on 4" casters)	Clear Door Opening	# of doors	Door Hinging	# of shelves
UPT2706RO-0300			A	B	C	D	E	F	G				
UPT2706LO-0300	7.7	6	27"	24 5/8"	25 7/8"	12"	9 3/8"	27"	42 3/4"	22 3/4"	1	Hinged Right (RO) Hinged Left (LO)	2
UPT2709RO-0300													
UPT2709LO-0300	7.7	9	27"	24 5/8"	25 7/8"	8"	9 5/8"	27"	44"	22 3/4"	1	Hinged Right (RO) Hinged Left (LO)	2
UPT3208RO-0300													
UPT3208LO-0300	9.3	8	32"	29 5/8"	30 13/16"	12"	9 3/8"	32"	42 3/4"	27 3/4"	1	Hinged Right (RO) Hinged Left (LO)	2
UPT3212RO-0300													
UPT3212LO-0300	9.3	12	32"	29 5/8"	30 13/16"	8"	9 5/8"	32"	44"	27 3/4"	1	Hinged Right (RO) Hinged Left (LO)	2
UPT4808LR-0300												Hinged Left/Right (LR)	
UPT4808LL-0300												Hinged Left/Left (LL)	
UPT4808RR-0300	14.0	8	48"	21 1/8"	21 1/8"	12"	9 3/8"	36 1/2"	42 3/4"	18"	2	Hinged Right/Right (RR)	4
UPT4812LR-0300												Hinged Left/Right (LR)	
UPT4812LL-0300												Hinged Left/Left (LL)	
UPT4812RR-0300	14.0	12	48"	21 1/8"	21 1/8"	12"	9 3/8"	48"	42 3/4"	18"	2	Hinged Right/Right (RR)	4
UPT4818LR-0300												Hinged Left/Right (LR)	
UPT4818LL-0300												Hinged Left/Left (LL)	
UPT4818RR-0300	14.0	18	48"	21 1/8"	21 1/8"	8"	9 5/8"	48"	44"	18"	2	Hinged Right/Right (RR)	4
UPT6012LR-0300												Hinged Left/Right (LR)	
UPT6012LL-0300												Hinged Left/Left (LL)	
UPT6012RR-0300	18.2	12	60"	24 5/8"	25 7/8"	12"	9 3/8"	48"	42 3/4"	22 3/4"	2	Hinged Right/Right (RR)	4
UPT6024LR-0300												Hinged Left/Right (LR)	
UPT6024LL-0300												Hinged Left/Left (LL)	
UPT6024RR-0300	18.2	24	60"	24 5/8"	25 7/8"	8"	9 5/8"	60"	44"	22 3/4"	2	Hinged Right/Right (RR)	4
UPT7212LR-0300												Hinged Left/Right (LR)	
UPT7212LL-0300												Hinged Left/Left (LL)	
UPT7212RR-0300	24.5	12	72"	29 5/8"	25 7/8"	12"	9 3/8"	48"	42 3/4"	27 3/4"	2	Hinged Right/Right (RR)	4
UPT7218LR-0300												Hinged Left/Right (LR)	
UPT7218LL-0300												Hinged Left/Left (LL)	
UPT7218RR-0300	24.5	18	72"	29 5/8"	30 13/16"	8"	9 5/8"	48"	44"	27 3/4"	2	Hinged Right/Right (RR)	4
UPT7224LR-0300												Hinged Left/Right (LR)	
UPT7224LL-0300												Hinged Left/Left (LL)	
UPT7224RR-0300	24.5	24	72"	29 5/8"	30 13/16"	8"	9 5/8"	60"	44"	27 3/4"	2	Hinged Right/Right (RR)	4
UPT7230LR-0300												Hinged Left/Right (LR)	
UPT7230LL-0300												Hinged Left/Left (LL)	
UPT7230RR-0300	24.5	30	72"	29 5/8"	30 13/16"	8"	9 5/8"	72"	44"	27 3/4"	2	Hinged Right/Right (RR)	4

NOTE: R290 model configurations are different than standard models.

<b>TRAUlsen</b> 4401 BLUE MOUND RD. PHONE 1 (800) 825-8220 Website: www.traulsen.com	FT. WORTH, TX 76106 FAX-MKTG. 1 (817) 624-4302	
---	---	--

Project

Quantity

Item #

Model Specified:

CSI Section 11400

## Top Pan Configuration

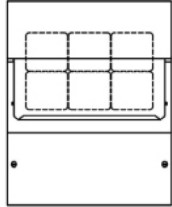

UPT276 Model

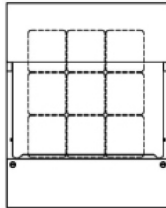

UPT279 Model

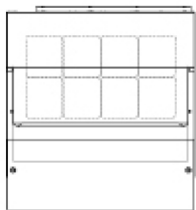

UPT328 Model

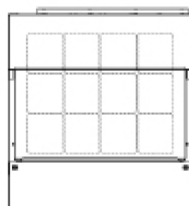

UPT3212 Model

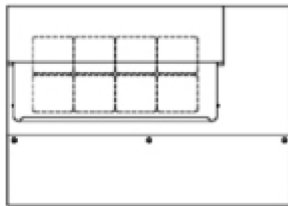

UPT488 Model

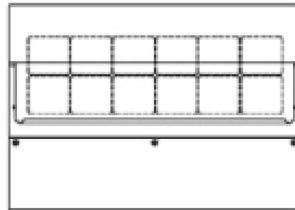

UPT4812 Model

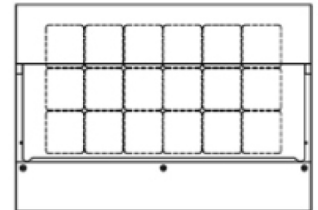

UPT4818 Model

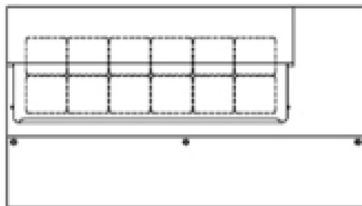

UPT6012 Model

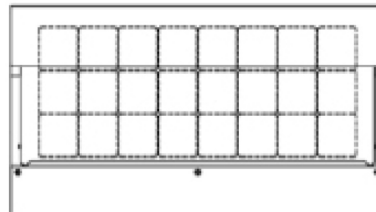

UPT6024 Model

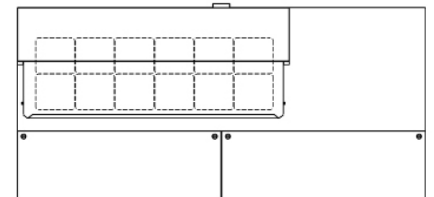

UPT7212 Model

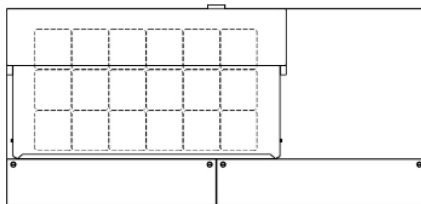

UPT7218 Model

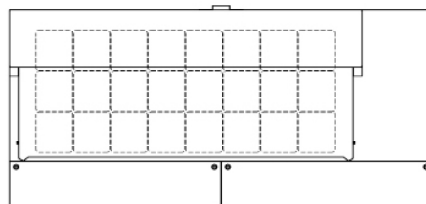

UPT7224 Model

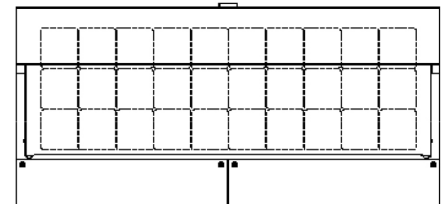

UPT7230 Model



TRAULSEN  
4401 BLUE MOUND RD.  
PHONE 1 (800) 825-8220  
Website: [www.traulsen.com](http://www.traulsen.com)

FT. WORTH, TX 76106  
FAX-MKTG. 1 (817) 624-4302

Project	Quantity	Item #
Model Specified:		CSI Section 11400

## Specifications

### Construction, Hardware and Insulation

Cabinet exterior front, sides, pan cover, lid and doors are constructed of stainless steel. Cabinet interior and door liners are constructed of anodized aluminum. The exterior cabinet back and bottom are constructed of galvanized steel.

Doors self close at less than 90 degrees and also includes a stay open feature at 105 degrees. Gasket profile and Santoprene® material simplify cleaning and increase overall gasket life.

Both the cabinet and doors are insulated with an average of 2" thick high density, non-CFC, foamed in place polyurethane.

A 3/4" thick, full-length, reversible white nylon cutting board is supplied standard.

### Pans & Cover

Each model is supplied standard with its full compliment of 4" deep plastic 1/6 size pans and stainless steel pan dividers. The pan cover and lid are constructed of stainless steel, and is easily removable for cleaning.

### Refrigeration System-R290

A balanced, rear mounted, front breathing, self-contained refrigeration system using R290 refrigerant is provided. It features a capillary tube metering device, air-cooled hermetic compressor, a forced air evaporator coil and a non-electric condensate evaporator. An 8' cord and plug is provided. Standard operating temperature of the refrigerated base is 34 to 38°F.

### Interior

Standard interior arrangements include two (2) powder coated wire shelves per door, mounted on pilasters. These are adjustable in 1/2" increments, allowing for a minimum of 1-1/2" spacing between shelves.

### Warranties

Both a three year parts and labor warranty and a five year compressor warranty (self-contained models only) are provided standard.

Electrical & Refrigeration Data			Shipping Data		
115/60/1 R290 NEMA 5-15P			(42"D x 56"H)		
Model	Full Load Amps	BTU/HR - HP	Width - crated	Volume - crated cu. ft.	Weight - lbs.
UPT2706R0-0300 UPT2706L0-0300	7.2	1525 (1/4)	45"	45	376 net/425 gross
UPT2709R0-0300 UPT2709L0-0300	7.2	1525 (1/4)	45"	45	376 net/425 gross
UPT3208R0-0300 UPT3208L0-0300	7.2	1525 (1/4)	45"	45	255 net/300 gross
UPT3212R0-0300 UPT3212L0-0300	7.2	1525 (1/4)	45"	45	255 net/300 gross
UPT4808LR-0300 UPT4808LL-0300 UPT4808RR-0300	7.2	1525 (1/4)	69"	69	355 net/400 gross
UPT4812LR-0300 UPT4812LL-0300 UPT4812RR-0300	7.2	1525 (1/4)	69"	69	355 net/400 gross
UPT4818LR-0300 UPT4818LL-0300 UPT4818RR-0300	7.2	1525 (1/4)	69"	69	355 net/400 gross
UPT6012LR-0300 UPT6012LL-0300 UPT6012RR-0300	7.2	1525 (1/4)	69"	69	457 net/500 gross
UPT6024LR-0300 UPT6024LL-0300 UPT6024RR-0300	7.2	1525 (1/4)	69"	69	457 net/500 gross
UPT7212LR-0300 UPT7212LL-0300 UPT7212RR-0300	7.2	1525 (1/4)	84"	84	548 net/575 gross
UPT7218LR-0300 UPT7218LL-0300 UPT7218RR-0300	7.2	1525 (1/4)	84"	84	548 net/575 gross
UPT7224LR-0300 UPT7224LL-0300 UPT7224RR-0300	7.2	1525 (1/4)	84"	84	548 net/575 gross
UPT7230LR-0300 UPT7230LL-0300 UPT7230RR-0300	7.2	1525 (1/4)	84"	84	548 net/575 gross

### NOTES:

- Overall depth figure includes standard cutting board.
- Height shown when mounted on 4" casters.
- Based on a 90 degree F ambient and 20 degree F evaporator.
- When ordering please specify: Voltage, Hinging, Optional Accessories and any additional warranties.
- This unit may be manufactured in other electrical characteristics and may have additional regulatory agency approvals. Consult factory for other electrical characteristics and agency approvals based on specific electrical and country requirements. (For exact electrical information and approval marks, always refer to the data label of the unit.)
- Continued product development may necessitate specification changes without notice.

Part No. TR35976 (revised 02-11-16)

TRAUlsen  
4401 BLUE MOUND RD.  
PHONE 1 (800) 825-8220  
Website: www.traulsen.com

FT. WORTH, TX 76106  
FAX-MKTG. 1 (817) 624-4302

