

Project	Quantity	Item #
Model Specified:		CSI Section 11400

Compact Sandwich Prep Tables/ Self-Contained



Model UST4818
(shown with optional casters)

27", 32, 48", 60" & 72" Wide Models



Stainless Exterior,
Anodized Alumi-
num Interior

27" Wide 6 Pan Model	UST276
27" Wide 9 Pan Model	UST279
32" Wide 8 Pan Model	UST328
32" Wide 12 Pan Model	UST3212
48" Wide 8 Pan Model	UST488
48" Wide 12 Pan Model	UST4812
48" Wide 18 Pan Model	UST4818
60" Wide 12 Pan Model	UST6012
60" Wide 24 Pan Model	UST6024
72" Wide 12 Pan Model	UST7212
72" Wide 18 Pan Model	UST7218
72" Wide 24 Pan Model	UST7224
72" Wide 30 Pan Model	UST7230

Traulsen's durable, high performance, sandwich prep tables provide a high quality/ high value alternative to the all too common commodity types in today's market.

Any comparison between prep tables should start with performance, and Traulsen really does the job. Not only do they all meet the NSF 7 Standard, but do so under real world conditions, even when using 6" deep pans! A Traulsen exclusive.

Truly front breathing, their design allows for "zero-clearance" installation. As a result they can be placed right up against the back wall and alongside other kitchen equipment, saving valuable floor space.

Standard Product Features

- High Quality Stainless Steel Exterior Top, Sides & Door(s)
- Durable, Corrosion Resistant Anodized Aluminum Interior
- Provides NSF Standard 7 Performance, Even When Using 6" Deep Pans - A Traulsen Exclusive
- Front Breathing Self-Contained Refrigeration System
- Standard Work Height 36-1/4" (see "optional accessory kits for lower height casters to meet ADA requirements or provide lower work heights).
- Environmentally Friendly R-134a Refrigerant
- Top Cut-Outs Accommodate Sixth Size Pans (divider bars and 4" deep plastic sixth size pans provided)
- Reinforced Pan Ledge (holds pans securely leveled, year after year)
- Stainless Steel Insulated Pan Lid with Two Open Positions
- Reversible, Full Length White Nylon Cutting Board
- Self-Closing Stainless Steel Doors With Convenient Stay Open Feature @ 105 Degrees
- Metal Door Handles
- Anodized Aluminum Interior Door Liners
- Interior Mounted Thermometer
- Two (2) Powder Coated Steel Shelves Per Door, Mounted On Adjustable Pilasters
- Automatic Non-Electric Condensate Evaporator
- Magnetic Snap-In Door Gaskets
- 8' Cord & Plug Attached
- Set of Four (4) 6" High Adjustable Legs (6 for 60" & 72" models)
- Three Year Parts And Labor Warranty
- Five Year Compressor Warranty

Optional Accessory Kits*

- **CASTER 5SET4** (four 6" high casters for 27", 32" & 48" models)
- **CASTER 5SET6** (six 6" high casters for 60" & 72" models)
- **CASTER SET4IN** (four 4" high casters for 27", 32" & 48" models)
- **CASTER 60SET3** (six 4" high casters for 60" & 72" models)
- **CASTER SET3IN** (four 3-1/2" high casters for 27", 32" & 48" models)
- **CASTER SET4** (six 3-1/2" high casters for 60" & 72" models)
- **CASTER SET2IN** (four 2-1/2" high casters for 27" models)
- **SHELF CPW1** (additional shelf for all 27" models)
- **SHELF CPW2** (additional shelf for all 32" models)
- **SHELF48 UPPER** (upper shelf for all 48" models)
- **SHELF48 LOWER** (lower shelf for all 48" models)
- **SHELF60 UPPER** (upper shelf for all 60" models)
- **SHELF60 LOWER** (lower shelf for all 60" models)
- **SHELF72 UPPER** (upper shelf for all 72" models)
- **SHELF72 LOWER** (lower shelf for all 72" models)

*All optional accessory kits are shipped separately for field installation.

Factory Installed Options

- Stainless Steel Finished Back
- Other Door Hingsings



Listed by Underwriters Laboratories Inc., to U.S. and Canadian safety standards and NSF International in accordance with ANSI/NSF7.

Approval: _____



TRAULSEN
4401 BLUE MOUND RD.
PHONE 1 (800) 825-8220
Website: www.traulsen.com

FT. WORTH, TX 76106
FAX-MKTG. 1 (817) 624-4302

Project

Quantity

Item #

Model Specified:

CSI Section 11400

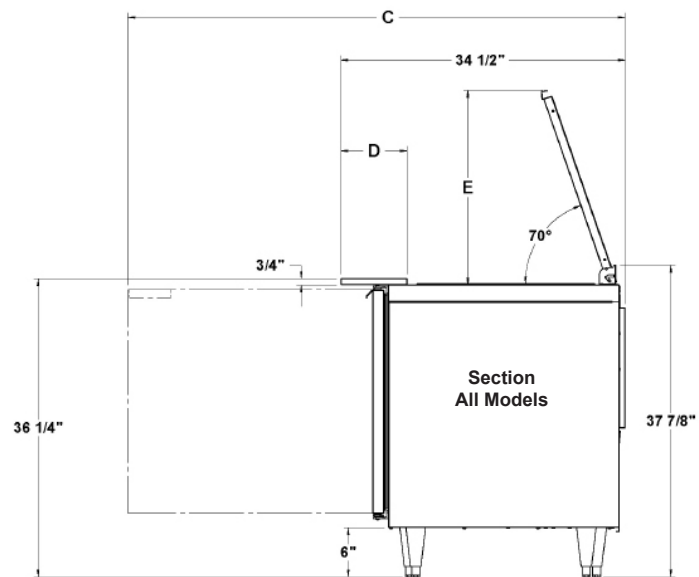
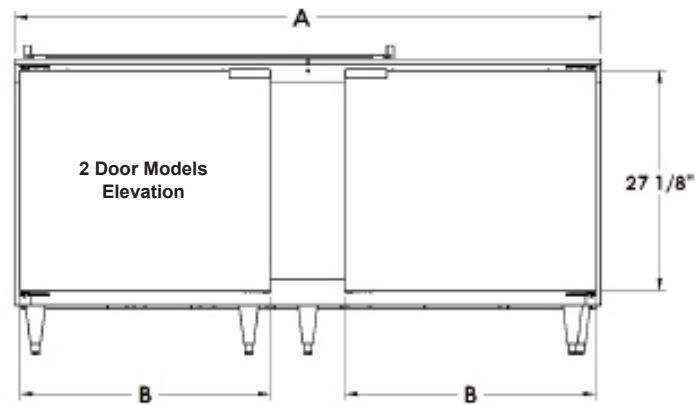
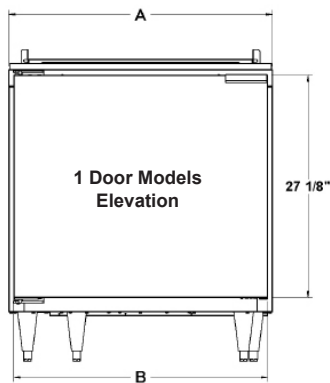

Cabinet Dimensional Data

Model	Storage cu. ft.	# Of 1/6 size pans top	A Width - cabinet	B Width - door	C Depth - door open 90°	D Depth-Cutting Board	E Height - Lid Open at 70 Degrees	Clear door opening	# of doors	# of shelves per cabinet	Total shelf area sq. ft.
UST276	7.1	6	27"	25 7/8"	55 3/8"	12"	16 1/4"	22 3/4"	1	2	4.88
UST279	7.1	9	27"	25 7/8"	55 3/8"	8"	22 3/16"	22 3/4"	1	2	4.88
UST328	8.8	8	32"	30 13/16"	60 3/8"	12"	17 1/2"	27 3/4"	1	2	6.13
UST3212	8.8	12	32"	30 13/16"	60 3/8"	8"	23 5/8"	27 3/4"	1	2	6.13
UST488	13.1	8	48"	21 1/8"	50 5/8"	12"	16 1/4"	18"	2	4	10.3
UST4812	13.1	12	48"	21 1/8"	50 5/8"	12"	16 1/4"	18"	2	4	10.3
UST4818	13.1	18	48"	21 1/8"	50 5/8"	8"	23 3/4"	18"	2	4	10.3
UST6012	16.7	12	60"	25 7/8"	55 3/8"	12"	16 1/4"	22 3/4"	2	4	13.2
UST6024	16.7	24	60"	25 7/8"	55 3/8"	8"	23 3/4"	22 3/4"	2	4	13.2
UST7212	20	12	72"	25 7/8"	60 3/8"	12"	16 1/4"	27 3/4"	2	4	15.5
UST7218	20	18	72"	30 13/16"	60 3/8"	8"	23 3/4"	27 3/4"	2	4	15.5
UST7224	20	24	72"	30 13/16"	60 3/8"	8"	23 3/4"	27 3/4"	2	4	15.5
UST7230	20	30	72"	30 13/16"	60 3/8"	8"	23 3/4"	27 3/4"	2	4	15.5

TRAUlsen
4401 BLUE MOUND RD.
PHONE 1 (800) 825-8220
Website: www.traulsen.com

FT. WORTH, TX 76106
FAX-MKTG. 1 (817) 624-4302

Traulsen

Project

Quantity

Item #

Model Specified:

CSI Section 11400

Top Pan Configuration

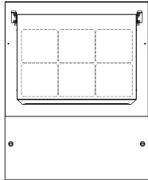

UST276 Model

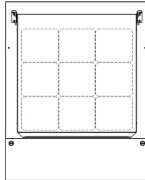

UST279 Model

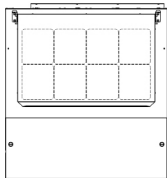

UST328 Model

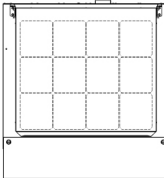

UST3212 Model

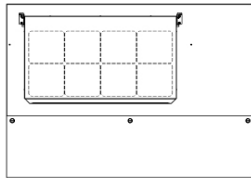

UST488 Model

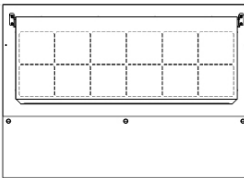

UST4812 Model

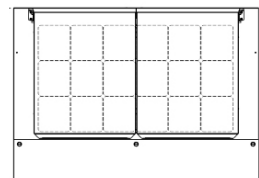

UST4818 Model

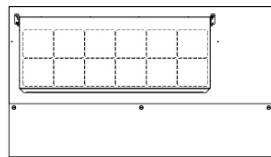

UST6012 Model

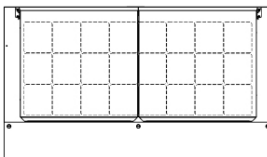

UST6024 Model

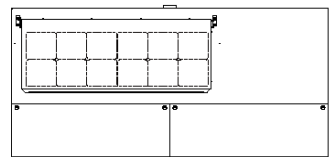

UST7212 Model

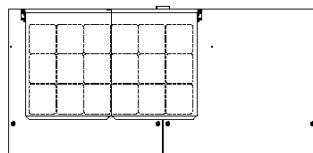

UST7218 Model

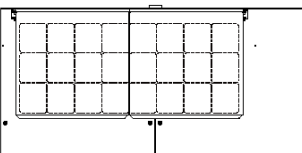

UST7224 Model

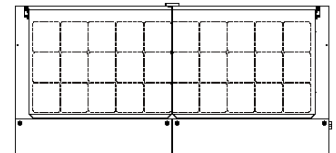

UST7230 Model



TRAULSEN
4401 BLUE MOUND RD.
PHONE 1 (800) 825-8220
Website: www.traulsen.com

FT. WORTH, TX 76106
FAX-MKTG. 1 (817) 624-4302

Project	Quantity	Item #
Model Specified:		CSI Section 11400

Specifications

Construction, Hardware and Insulation

Cabinet exterior front, one piece sides, pan lid, and doors are constructed of 22 gauge stainless steel. Cabinet interior and door liners are constructed of anodized aluminum. The exterior cabinet back and bottom are constructed of galvanized steel.

Doors self close at less than 90 degrees and also includes a stay open feature at 105 degrees. Easily removable for cleaning, vinyl magnetic door gasket assures tight door seal.

Both the cabinet and doors are insulated with an average of 2" thick high density, non-CFC, foamed in place polyurethane.

A 3/4" thick, full-length, reversible white nylon cutting board is supplied standard.

Pans & Cover

Each model is supplied standard with its full compliment of 4" deep plastic 1/6 size pans and stainless steel pan dividers. The insulated lift-up pan cover is constructed of stainless steel, and is easily removable for cleaning.

Refrigeration System

A balanced, rear mounted, front breathing, self-contained refrigeration system using R-134a refrigerant is provided. It features a capillary tube metering device, air-cooled hermetic compressor, a forced air evaporator coil and a non-electric condensate evaporator. An 8' cord and plug is provided. Standard operating temperature of the refrigerated base is 34 to 38°F.

Interior

Standard interior arrangements include two (2) powder coated wire shelves per door, mounted on pilasters. These are adjustable in 1/2" increments, allowing for a minimum of 1-1/2" spacing between shelves.

Warranties

Both a three year parts and labor warranty and a five year compressor warranty (self-contained models only) are provided standard.

Electrical & Refrigeration Data			Shipping Data		
115/60/1 R-134a NEMA 5-15P			(42"D x 41"H)		
Model	Full Load Amps	BTU/HR - HP	Width - crated	Volume - crated cu. ft.	Weight - lbs.
UST276	4.7	1020 (1/5 HP)	45"	45	376 net/425 gross
UST279	4.7	1020 (1/5 HP)	45"	45	376 net/425 gross
UST328	6.2	1020 (1/5 HP)	45"	45	255 net/300 gross
UST3212	6.2	1020 (1/5 HP)	45"	45	255 net/300 gross
UST488	5.5	1600 (1/4 HP)	69"	69	355 net/400 gross
UST4812	5.5	1600 (1/4 HP)	69"	69	355 net/400 gross
UST4818	5.5	1600 (1/4 HP)	69"	69	355 net/400 gross
UST6012	5.5	1600 (1/4 HP)	69"	69	457 net/500 gross
UST6024	5.5	1600 (1/4 HP)	69"	69	457 net/500 gross
UST7212	6.3	1600 (1/4 HP)	84"	84	548 net/575 gross
UST7218	6.3	1600 (1/4 HP)	84"	84	548 net/575 gross
UST7224	6.3	1600 (1/4 HP)	84"	84	548 net/575 gross
UST7230	6.3	1600 (1/4 HP)	84"	84	548 net/575 gross

NOTES:

- Overall depth figure includes standard cutting board.
- Height shown when mounted on 6" high legs or casters.
- Based on a 90 degree F ambient and 20 degree F evaporator.
- When ordering please specify: Voltage, Hinging, Optional Accessories and any additional warranties.
- Continued product development may necessitate specification changes without notice.

Part No. TR35821 (revised 1/13)

TRAUlsen
 4401 BLUE MOUND RD.
 PHONE 1 (800) 825-8220
 Website: www.traulsen.com

FT. WORTH, TX 76106
 FAX-MKTG. 1 (817) 624-4302

