



**TRUE FOOD SERVICE EQUIPMENT, INC.**

2001 East Terra Lane • O'Fallon, Missouri 63366-4434 • (636)240-2400  
 Fax (636)272-2408 • Toll Free (800)325-6152 • Intl Fax# (001)636-272-7546  
 Parts Dept. (800)424-TRUE • Parts Dept. Fax# (636)272-9471 • www.truemfg.com

Project Name: \_\_\_\_\_

Location: \_\_\_\_\_

Item #: \_\_\_\_\_ Qty: \_\_\_\_\_

Model #: \_\_\_\_\_

A/A #

SIS #

Model:  
TFP-72-30M

**Food Prep Table:**  
Food Prep Unit



**TFP-72-30M**

- ▶ True's food prep units are designed with enduring quality that protects your long term investment.
- ▶ Energy saving, environmentally friendly (134A), exclusive forced-air refrigeration system holds 33°F to 41°F (.5°C to 5°C).
- ▶ All stainless steel front, top and ends. Matching aluminum finished back.
- ▶ Stainless steel, patented, foam insulated lid and hood keep pan temperatures colder, lock in freshness and minimize condensation. Removable for easy cleaning.
- ▶ 8" (204 mm) deep, ½" (13 mm) thick, full length removable cutting board included. Sanitary, high density, NSF approved white polyethylene provides tough preparation surface.
- ▶ Doors fitted with 12" (305 mm) long recessed handle that is foamed-in-place with a sheet metal interlock to ensure permanent attachment.
- ▶ Foamed-in-place using Ecomate. A high density, polyurethane insulation that has zero ozone depletion potential (ODP) and zero global warming potential (GWP).

**ROUGH-IN DATA**

Specifications subject to change without notice.  
 Chart dimensions rounded up to the nearest 1/8" (millimeters rounded up to next whole number).

Model	Doors	Shelves	Pans (top)	Cabinet Dimensions (inches) (mm)			HP	Voltage	Amps	NEMA Config.	Cord Length (total ft.) (total m)	Crated Weight (lbs.) (kg)
				L	D†	H*						
TFP-72-30M	3	6	30	72 1/8 1832	31 1/2 801	45 3/4 1162	1/3 N/A	115/60/1	5.1 N/A	5-15P	7 2.13	530 241

† Depth does not include 2" (51 mm) for cutting board.  
 \* Height does not include 3/4" (19 mm) for castors.

	<b>APPROVALS:</b>	<b>AVAILABLE AT:</b>
	9/13 Printed in U.S.A.	

Model:  
TFP-72-30M

## Food Prep Table: Food Prep Unit



### STANDARD FEATURES

#### DESIGN

- True's commitment to using the highest quality materials and oversized refrigeration systems provides the user with colder product temperatures, lower utility costs, exceptional food safety and the best value in today's food service marketplace.

#### REFRIGERATION SYSTEM

- Factory engineered, self-contained, capillary tube system using environmentally friendly (CFC free) 134A refrigerant.
- Energy saving, factory balanced refrigeration system with guided airflow to provide uniform temperature in food pans and cabinet interior.
- Exclusive forced-air design holds 33°F to 41°F (.5°C to 5°C) product temperature in food pans and cabinet interior. Complies with and listed under ANSI/NSF-7-1997-6.3.
- High efficiency evaporator fan motor and larger fan blades give True Food Prep units a more efficient, low velocity, high volume airflow design.
- Easy access to all condensing unit components from back of cabinet.

#### CABINET CONSTRUCTION

- Exterior - stainless steel front, top and ends. Matching aluminum finished back.
- Interior - attractive, NSF approved, white aluminum liner. Stainless steel floor with coved corners.

- Insulation - entire cabinet structure and drawer facings are foamed-in-place using Ecomate. A high density, polyurethane insulation that has zero ozone depletion potential (ODP) and zero global warming potential (GWP).
- 2 1/2" (64 mm) diameter castors - locks provided on front set.
- Solid State Electronic Control, accessible on back of the unit.

#### DOORS

- Stainless steel exterior with white aluminum liner to match cabinet interior.
- Doors fitted with 12" (305 mm) long recessed handle that is foamed-in-place with a sheet metal interlock to ensure permanent attachment.
- Magnetic door gaskets of one piece construction, removable without tools for ease of cleaning.

#### SHELVING

- Six (6) adjustable, heavy duty PVC coated wire shelves. Left and right section shelves 21 1/2"L x 20"D (547 mm x 508 mm). Center shelves 23"L x 20"D (585 mm x 508 mm). Four (4) chrome plated shelf clips included per shelf.
- Shelf support pilasters made of same material as cabinet interior; shelves are adjustable on 1/2" (13 mm) increments.

#### MODEL FEATURES

- Evaporator is epoxy coated to eliminate the potential of corrosion.

- 8" (204 mm) deep, full length removable cutting board. Sanitary, high-density, NSF approved white polyethylene provides tough preparation surface.
- Stainless steel, patented, foam insulated lid and hood keep pan temperatures colder, lock in freshness and minimize condensation. Removable for easy cleaning.
- Comes standard with 30 (1/8 size) 6 7/8"L x 6 1/4"W x 4"D (175 mm x 159 mm x 102 mm) clear polycarbonate, NSF approved, food pans in countertop prep area.
- Countertop pan opening designed to fit varying size pan configurations with available pan divider bars. Varying size pans supplied by others.
- NSF-7 compliant for open food product.

#### ELECTRICAL

- Unit completely pre-wired at factory and ready for final connection to a 115/60/1 phase, 15 amp dedicated outlet. Cord and plug set included.



115/60/1  
NEMA-5-15R

#### OPTIONAL FEATURES/ACCESSORIES

Upcharge and lead times may apply.

- Pan dividers.
- Single oversheff.
- Double oversheff.

### PLAN VIEW

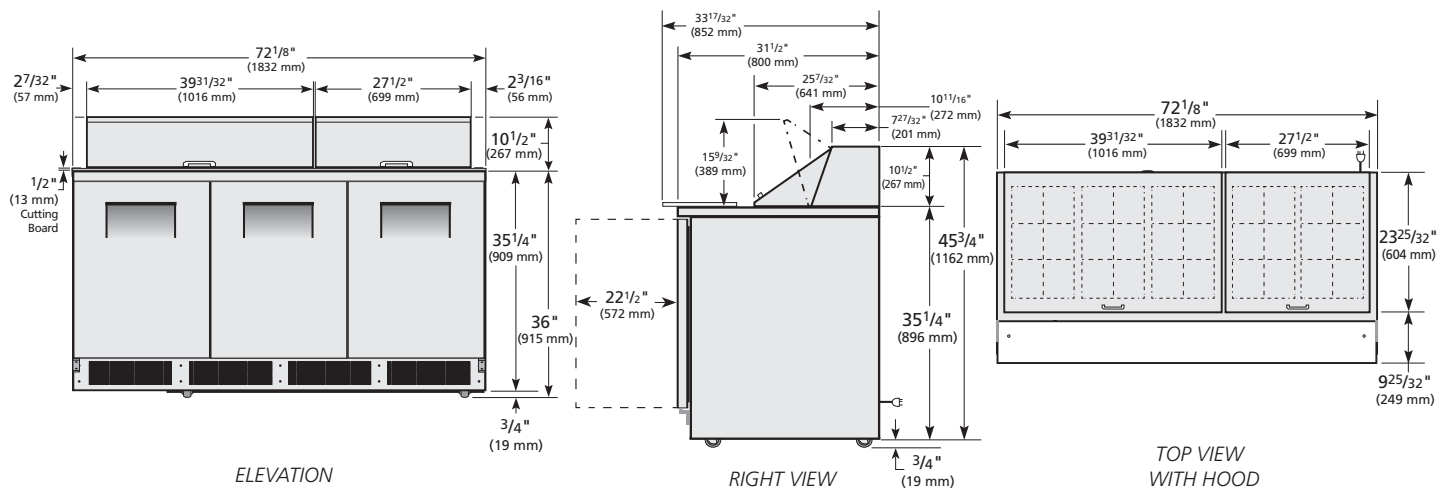

**WARRANTY**  
Three year warranty on all parts and labor and an additional 2 year warranty on compressor. (U.S.A. only)

METRIC DIMENSIONS ROUNDED UP TO THE NEAREST WHOLE MILLIMETER  
SPECIFICATIONS SUBJECT TO CHANGE WITHOUT NOTICE



Model	Elevation	Right	Plan	3D	Back
TFP-72-30M					

### TRUE FOOD SERVICE EQUIPMENT