



ADA Compliant

This Space for Architect/Engineer Approval

Job Name _____ Date _____

Model Specified _____ Quantity _____

Customer/Wholesaler _____

Contractor _____

Architect/Engineer _____

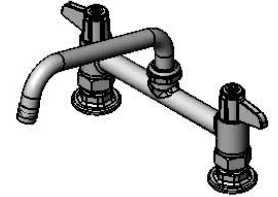
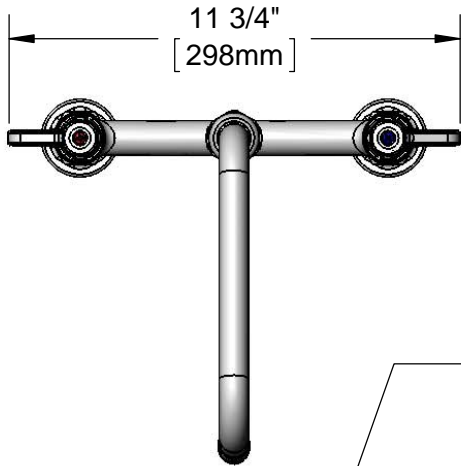

5SP-08
8" equip Swing Nozzle
w/ Laminar Flow Device.
Rigid Conversion Requires
014200-45 Lock Washer
(Sold Separately)

Ceramic Cartridges &
equip Lever Handles
w/ Color Coded Screws

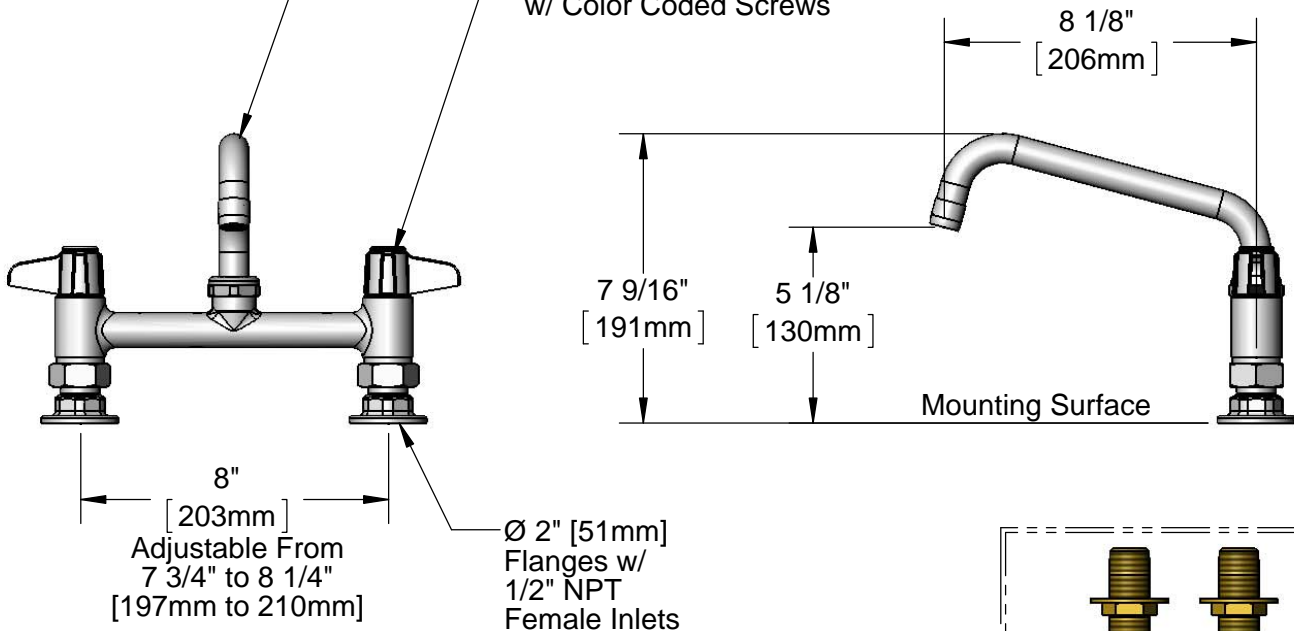

B-0425-M
Supply Nipple Kit
(Sold Separately)

Model Number
5F-8DLX08

Date
06/05/12

Scale
1:4

Drawn
DHL

Checked
DMH

Approved
JHB



Product Specifications:

**8" Deck Mount Mixing Faucet w/ Ceramic Cartridges,
equip Lever Handles, 8" equip Swing Nozzle
& 1/2" NPT Female Inlets**

equip Foodservice Accessories
2 Saddleback Cove, P.O. Box 1088
Travelers Rest, South Carolina 29690
Phone: 800.891.4808 Fax: 800.868.0084

ITEM NO.	SALES NO.	DESCRIPTION
1	014250-45	Laminar Flow Device
2	5SP-08	8" equip Swing Nozzle
3	013839-25	equip Swivel Nut
4	013848-45	equip Swivel Piece O-Ring
5	5-HDL-L	equip Lever Handle w/ Color Coded Screws
6	013788-45	equip Ceramic Cartridge, LTC
7	001019-45	Coupling Nut Washer
8	00AA	1/2" NPT Inlet Flange
9	013787-45	equip Ceramic Cartridge, RTC

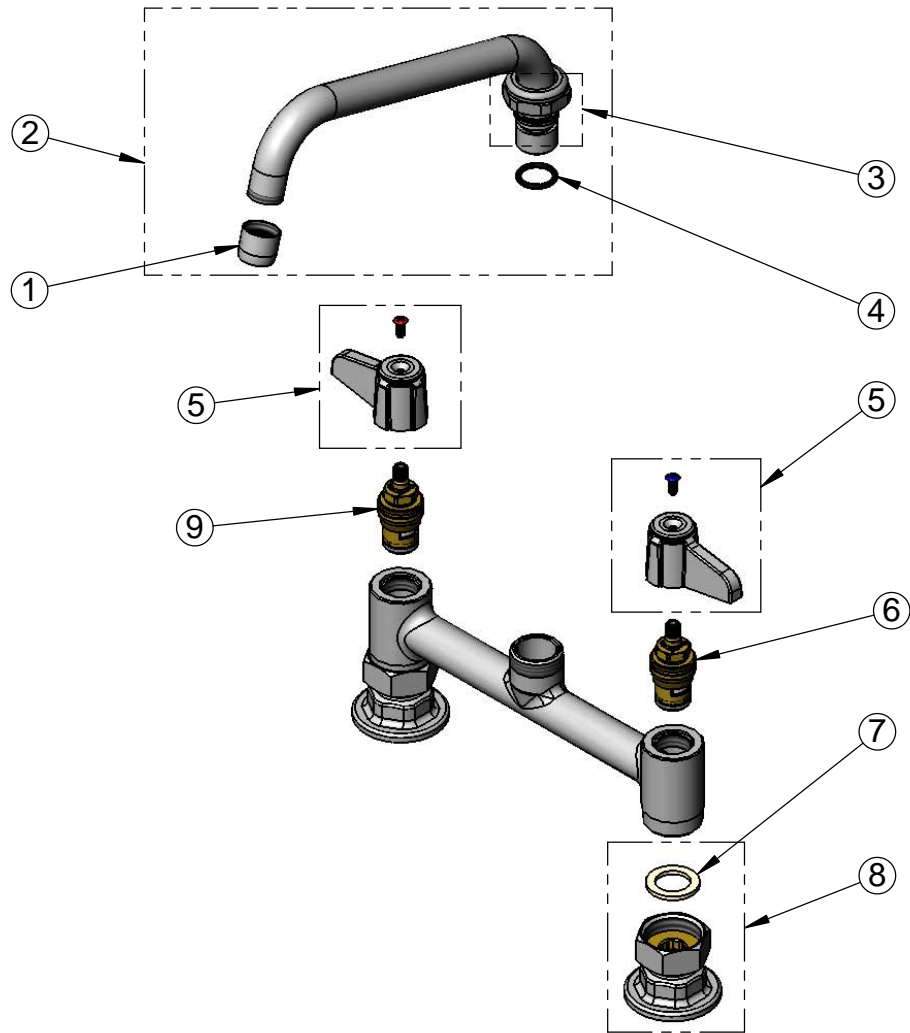

Model Number 5F-8DLX08	Date 06/05/12	Scale NTS	Drawn DHL	Checked DMH	Approved JHB
---------------------------	------------------	--------------	--------------	----------------	-----------------



Product Specifications:

**8" Deck Mount Mixing Faucet w/ Ceramic Cartridges,
equip Lever Handles, 8" equip Swing Nozzle
& 1/2" NPT Female Inlets**

equip Foodservice Accessories
2 Saddleback Cove, P.O. Box 1088
Travelers Rest, South Carolina 29690
Phone: 800.891.4808 Fax: 800.868.0084