

This Space For Architect/Engineer Approval
 Job Name _____ Date _____
 Model Specified _____ Quantity _____
 Customer/Wholesaler _____
 Contractor _____
 Architect/Engineer _____

STAINLESS STEEL
 OUTER COVERING,
 RUBBER INNER HOSE

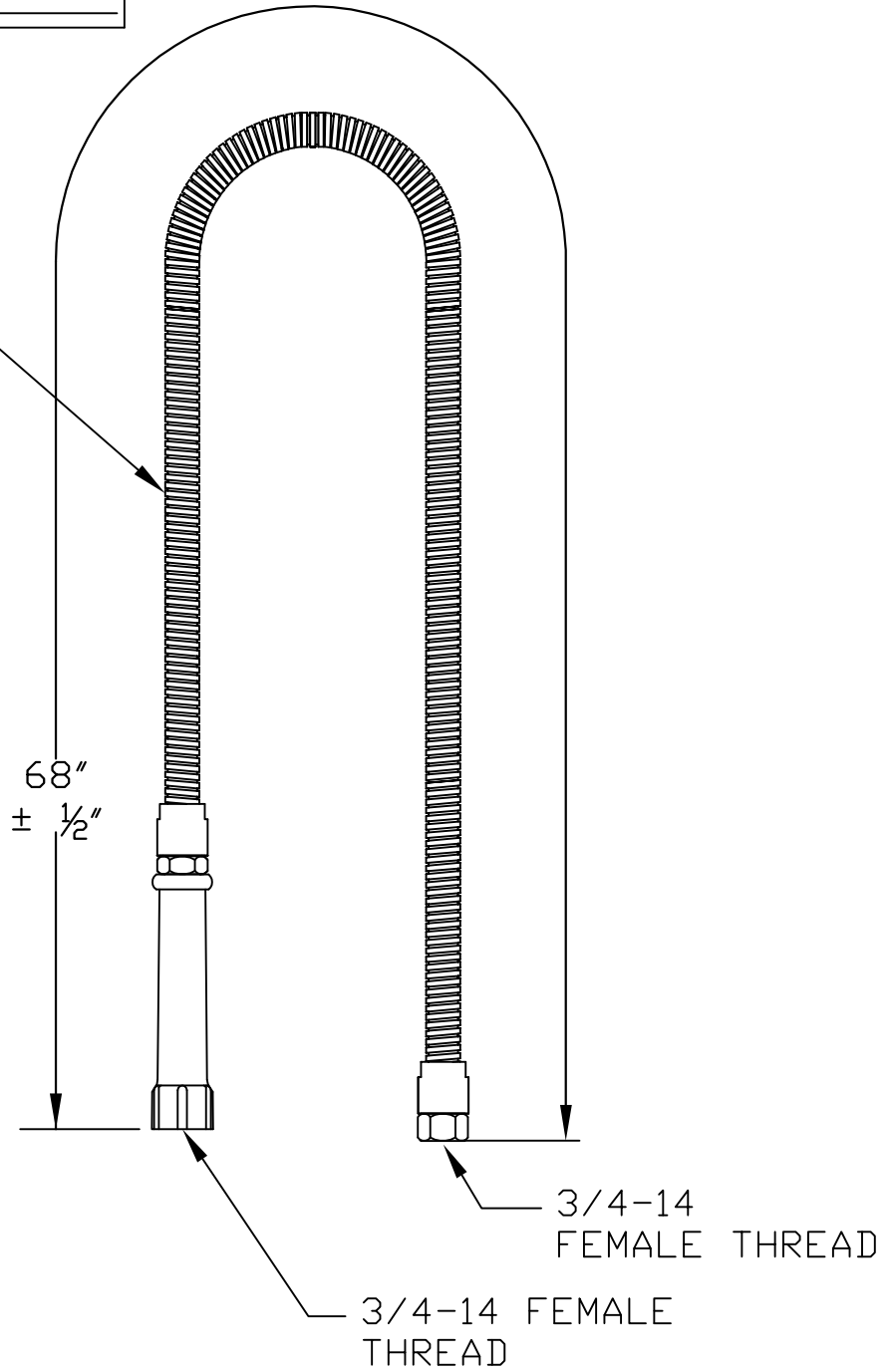

MODEL NUMBER 5HSE68	DATE 5/5/06	SCALE NTS	DRAWN WJS	CHECKED JRM	APPROVED JHB
------------------------	----------------	--------------	--------------	----------------	-----------------



DESCRIPTION
 68" HOSE ASSEMBLY FOR PRE-RINSE UNIT

equip Foodservice Accessories
 P.O. BOX 1088, 2 SADDLEBACK COVE
 TRAVELERS REST, SOUTH CAROLINA 29690
 PHONE: 800.891.4808 FAX: 800.868.0084