



**T&S BRASS AND BRONZE WORKS, INC.**  
 2 Saddleback Cove / P.O. Box 1088  
 Travelers Rest, SC 29690

Model No.  
**B-0032-H**

Item No.

Travelers Rest, SC: 800-476-4103 • Simi Valley, CA: 800-423-0150 • Fax: 864-834-3518 • www.tsbrass.com

This Space for Architect/Engineer Approval

Job Name \_\_\_\_\_ Date \_\_\_\_\_

Model Specified \_\_\_\_\_ Quantity \_\_\_\_\_

Customer/Wholesaler \_\_\_\_\_

Contractor \_\_\_\_\_

Architect/Engineer \_\_\_\_\_

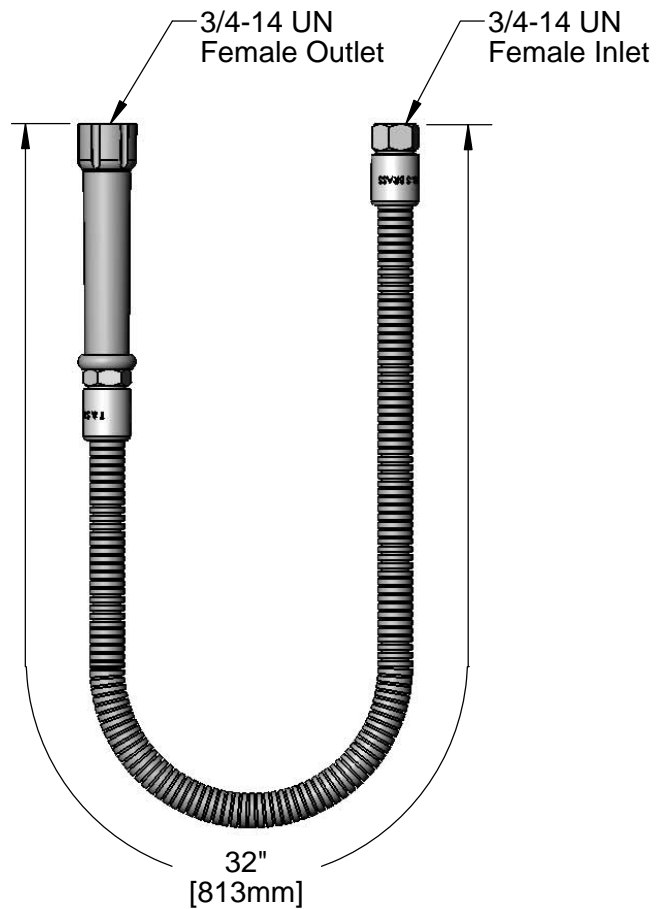

  
 (2) 010476-45  
 Washers  
 (Included)

Product Specifications:  
 32" Stainless Steel Flex Hose w/  
 Gray Handle & Polyurethane Inner Hose

Drawn <b>DHL</b>	Checked <b>DMH</b>	Approved <b>JHB</b>
Scale: <b>1:4</b>		Date: <b>08/27/12</b>



**T&S BRASS AND BRONZE WORKS, INC.**  
 2 Saddleback Cove / P.O. Box 1088  
 Travelers Rest, SC 29690

Model No.  
**B-0032-H**

Item No.

Travelers Rest, SC: 800-476-4103 • Simi Valley, CA: 800-423-0150 • Fax: 864-834-3518 • www.tsbrass.com

ITEM NO.	SALES NO.	DESCRIPTION
1	001014-45	Washer, B-0100 Hose Barrel
2	002987-40	Gray Grip Handle
3	010476-45	#27 Washer
4	000729-40	Nut, 7/8"-20 Male x 3/4"-14 Female

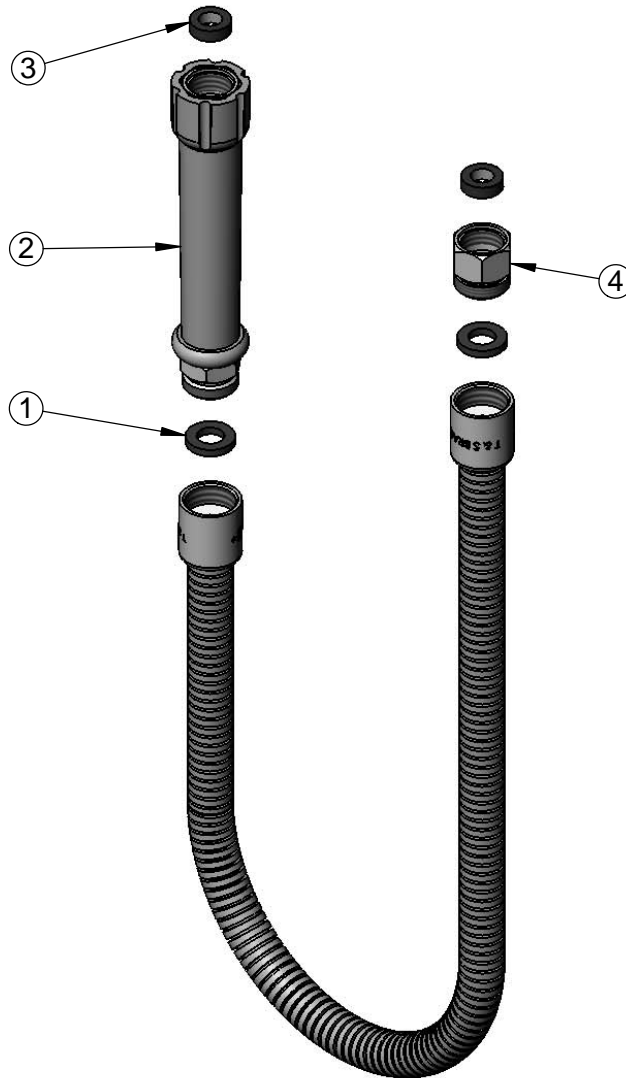

Product Specifications:  
 32" Stainless Steel Flex Hose w/  
 Gray Handle & Polyurethane Inner Hose

Drawn <b>DHL</b>	Checked <b>DMH</b>	Approved <b>JHB</b>
Scale: <b>NTS</b>		Date: <b>08/27/12</b>