

T&S BRASS AND BRONZE WORKS, INC.

2 SADDLEBACK COVE / P.O. BOX 1088 / TRAVELERS REST, SC 29690

PHONE 800-476-4103 - FAX 864- 834-3518



REG.#A2601
ISO #9001

Model No.

B-1107

**RELIABILITY
BUILT IN**

Job Name:

Architect/Engineer Approval:

Notes:

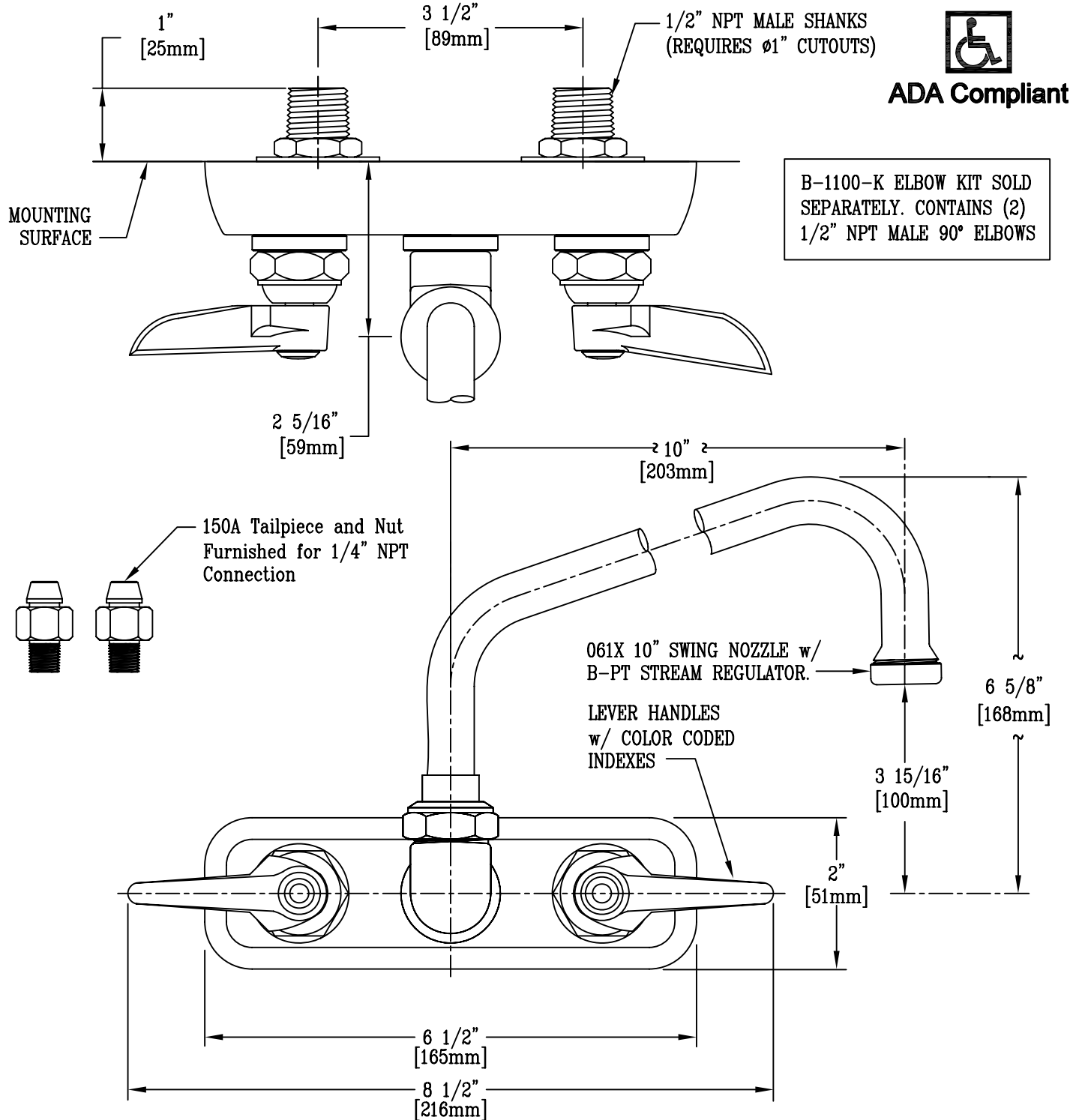

Product Description:

WALL MOUNT WORKBOARD FAUCET WITH 1/2" NPT MALE SHANKS, 3 1/2" INLET CENTERS, 061X 10" SWING NOZZLE, B-PT STREAM REGULATOR & LEVER HANDLES

Drawn:

KJG

Checked

JRM

Scale:

1 : 2

Approved

JHB

Date:

12/19/07