



T&S BRASS AND BRONZE WORKS, INC.

2 Saddleback Cove / P.O. Box 1088
Travelers Rest, SC 29690

Model No.

B-1210-12-WFK

Item No.

Travelers Rest, SC: 800-476-4103 • Simi Valley, CA: 800-423-0150 • Fax: 864-834-3518 • www.tsbrass.com



ADA Compliant

This Space for Architect/Engineer Approval

Job Name _____ Date _____

Model Specified _____ Quantity _____

Customer/Wholesaler _____

Contractor _____

Architect/Engineer _____

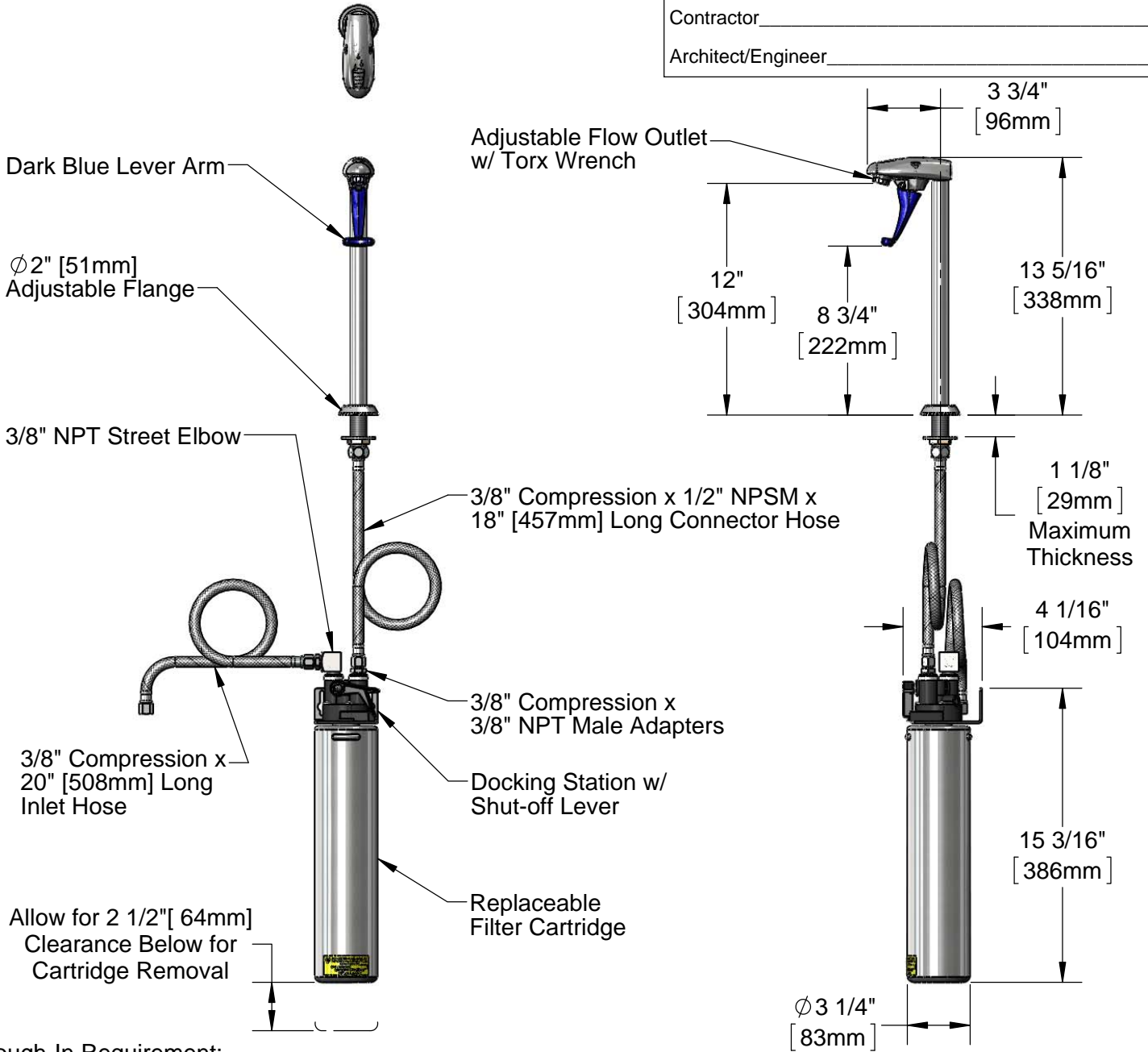

Rough-In Requirement:
Ø 1" [25mm] Mounting Hole

Product Specifications:
12" Pedestal Type Glass Filler w/ Water Filtration Kit

Drawn DMH	Checked JRM	Approved JHB
Scale: 1:8		Date: 01/16/14



T&S BRASS AND BRONZE WORKS, INC.

2 Saddleback Cove / P.O. Box 1088
Travelers Rest, SC 29690

Model No.

B-1210-12-WFK

Item No.

Travelers Rest, SC: 800-476-4103 • Simi Valley, CA: 800-423-0150 • Fax: 864-834-3518 • www.tsbrass.com

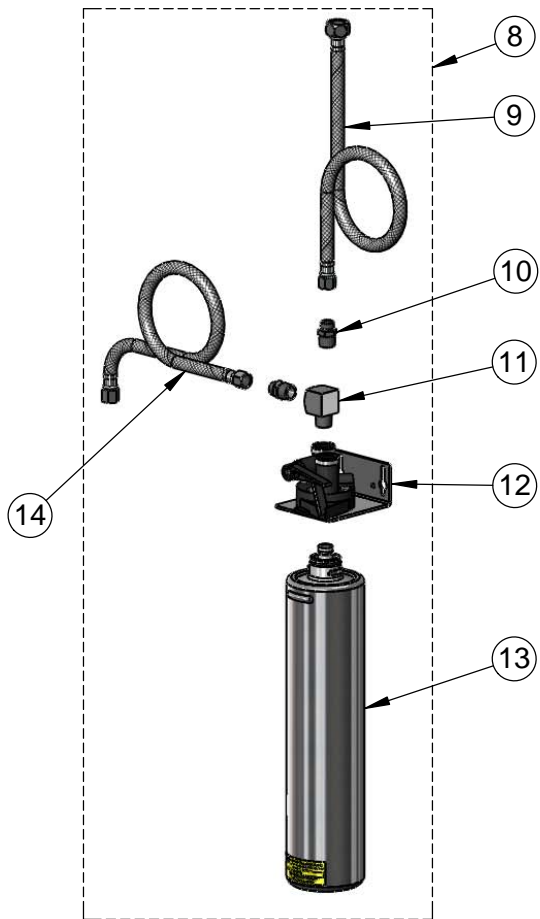
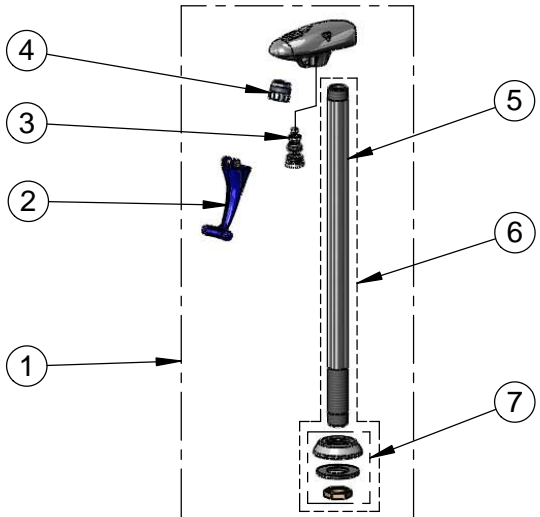

ITEM NO.	SALES NO.	DESCRIPTION
1	B-1210-12	12" Pedestal Type Glass Filler
2	015550-45	Lever Arm Repair Kit
3	015589-40	Valve Assembly
4	015588-40	Adjustable Outlet w/ Torx Wrench
5	015890-40	B-1210-12 Pedestal
6	015891-40	Pedestal Assembly
7	016783-40	Adjustable Deck Flange Repair Kit
8	B-WKF	Water Filtration Kit
9	5EF-0005	Supply Hose, 9/16-24 Female x 1/2" NPSM
10	006101-45	Adapter, 3/8" NPT x 9/16"-24 UN Male
11	148X	3/8 Street Elbow
12	B-WFDS	Water Filtration Docking Station
13	B-WFC	Filter Cartridge
14	013146-45	Supply Hose, 9/16-24 Fem (3/8" Comp)



016640-45
T-45 Torx Wrench
for Adjustable Outlet

Product Specifications:
12" Pedestal Type Glass Filler w/ Water Filtration Kit

Drawn DMH	Checked JRM	Approved JHB
Scale: NTS		Date: 01/16/14