



T&S BRASS AND BRONZE WORKS, INC.

2 Saddleback Cove / P.O. Box 1088
Travelers Rest, SC 29690

Model No.

B-1220

Item No.

Travelers Rest, SC: 800-476-4103 • Simi Valley, CA: 800-423-0150 • Fax: 864-834-3518 • www.tsbrass.com

This Space for Architect/Engineer Approval

Job Name _____ Date _____

Model Specified _____ Quantity _____

Customer/Wholesaler _____

Contractor _____

Architect/Engineer _____



ADA Compliant

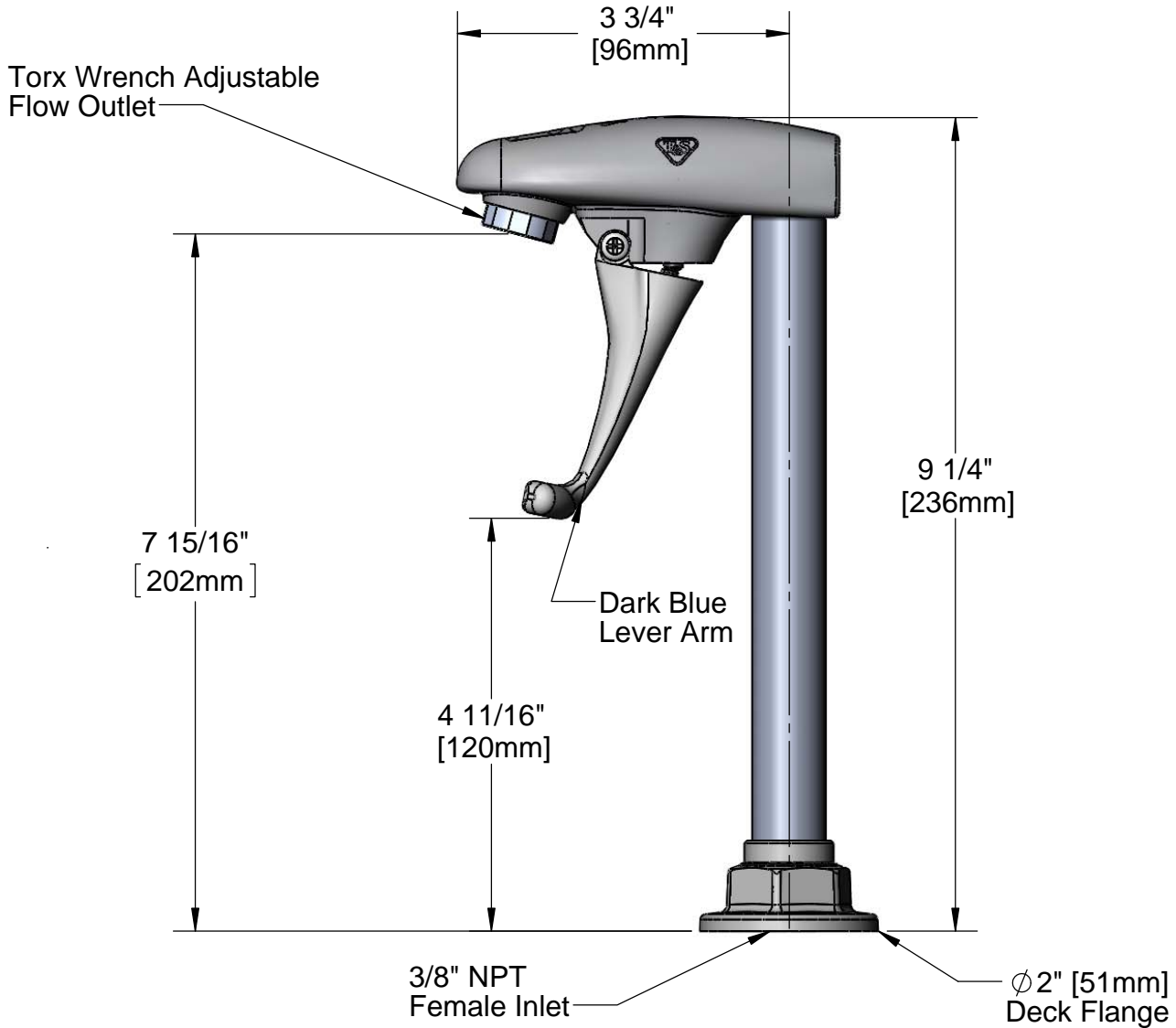
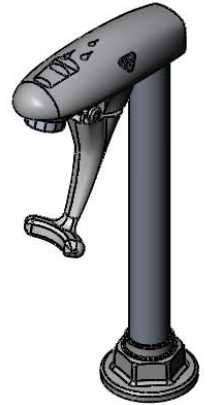

Product Specifications:
8" Pedestal Glass Filler, Push Back Design,
3/8" NPT Female Inlet, Dark Blue Self-Closing Arm
Designed for Water Coolers

Drawn

JRM

Checked

DMH

Approved

JHB

Scale:

1:2

Date:

01/24/13



T&S BRASS AND BRONZE WORKS, INC.

2 Saddleback Cove / P.O. Box 1088
Travelers Rest, SC 29690

Model No.

B-1220

Item No.

Travelers Rest, SC: 800-476-4103 • Simi Valley, CA: 800-423-0150 • Fax: 864-834-3518 • www.tsbrass.com

ITEM NO.	SALES NO.	DESCRIPTION
1	015588-40	Adjustable Outlet w/ Torx Wrench
2	015589-40	Valve Assembly
3	015550-45	Lever Arm Repair Kit
4	015982-40	B-1220 8" Pedestal & Flange

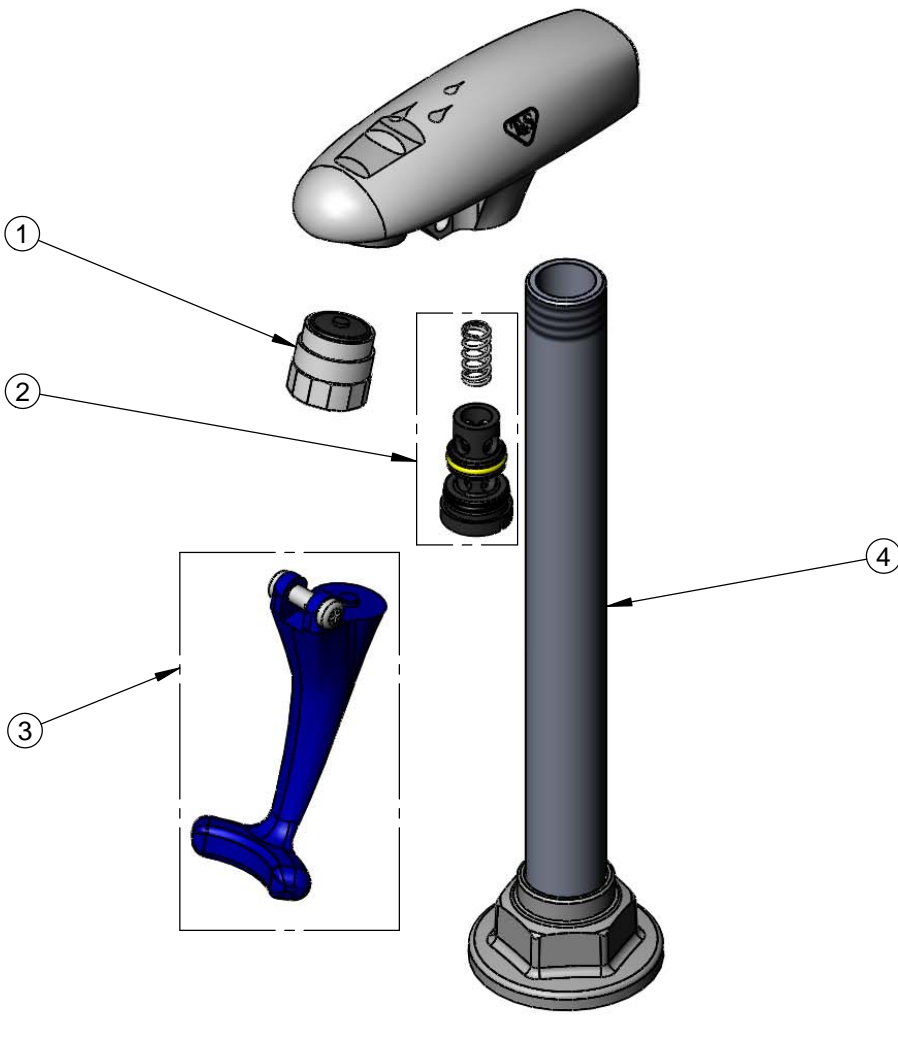

Product Specifications:
8" Pedestal Glass Filler, Push Back Design,
3/8" NPT Female Inlet, Dark Blue Self-Closing Arm
Designed for Water Coolers

Drawn JRM	Checked DMH	Approved JHB
Scale: NTS		Date: 01/24/13